

OUTDOOR LIVING DESIGNS

LENZA

45 X 99 L-SHAPE GRILL TOP - LEFT DOOR DESIGN

LENZA - 45 x 99 L-SHAPE GRILL TOP - LEFT DOOR DESIGN

OUTDOOR LIVING DESIGNS

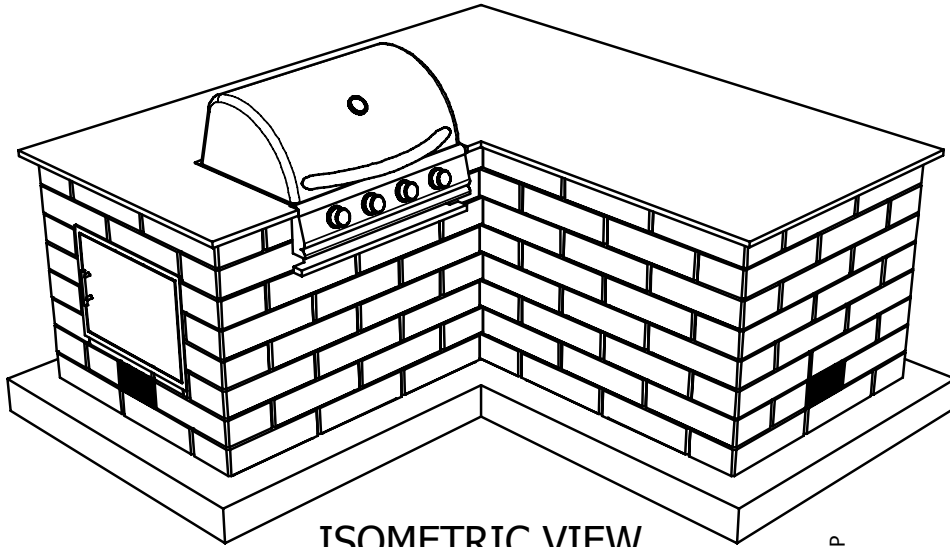

ISOMETRIC VIEW

NOTE:

1. WALL UNITS TO BE INSTALLED WITH CHANNEL ON THE BOTTOM SIDE IN ORDER TO GET THE PROPER CONTEMPORARY ESTHETIC LOOK. (WALL PRODUCT TO BE INVERTED 180 DEGREES FROM FINISHED PALLET WHEN INSTALLED).
2. SECURE EACH UNIT USING APPROVED ADHESIVE OR BONDING AGENT FOLLOWING APPLICATION DIRECTIONS PROVIDED BY PRODUCT SUPPLIER.
3. THIS DESIGN REQUIRES CUTTING UNITS TO PROPERLY FIT THE GRILL TOP AND ACCESS DOOR.
4. BUILT-IN GRILL INSERT AND ACCESS DOOR TO BE INSTALLED PER MANUFACTURES RECOMMENDATIONS.
5. STRUCTURAL SUPPORT FOR BLOCK UNITS OVER OPENINGS NOT SHOWN FOR VISUAL PURPOSES.
6. FOR PROPER INSTALLATION OF GAS GRILL REFER TO BLAZE OUTDOOR PRODUCTS - USE & CARE GUIDE GAS GRILL BLZ-4LBM 9NG/LP).
7. ALL DIMENSIONS ARE IN INCHES.

BLAZE 28-INCH SINGLE ACCESS DOOR HINGED (HORIZONTAL)
PART# BLZ-SH-2417-R-SC

2" TYPICAL OVERHANG PER SIDE

FINISHED GRADE

VENT 5" X 9"

SIDE ELEVATION VIEW

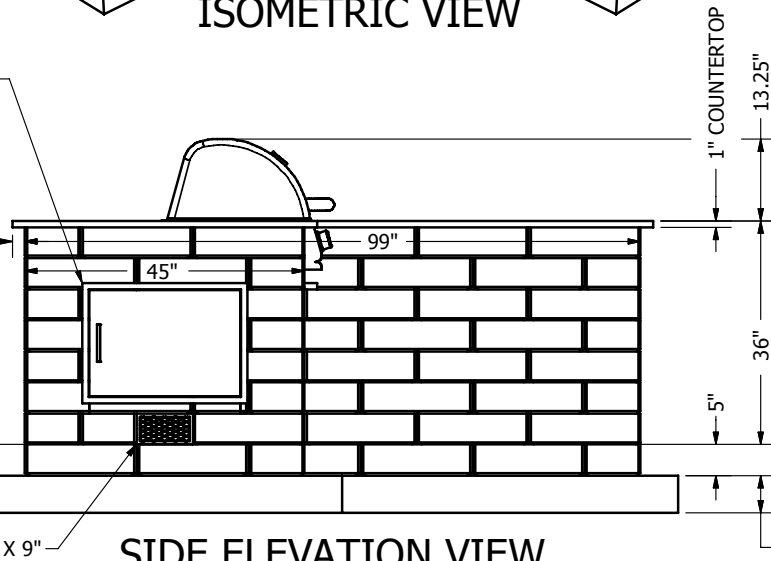

BLAZE PRELUDE LBM 32-INCH 4-BURNER GRILL
PART# BLZ-4LBM-LP/NG

GRILL FILLER PIECE

2" TYPICAL OVERHANG PER SIDE

FINISHED GRADE

FRONT ELEVATION VIEW

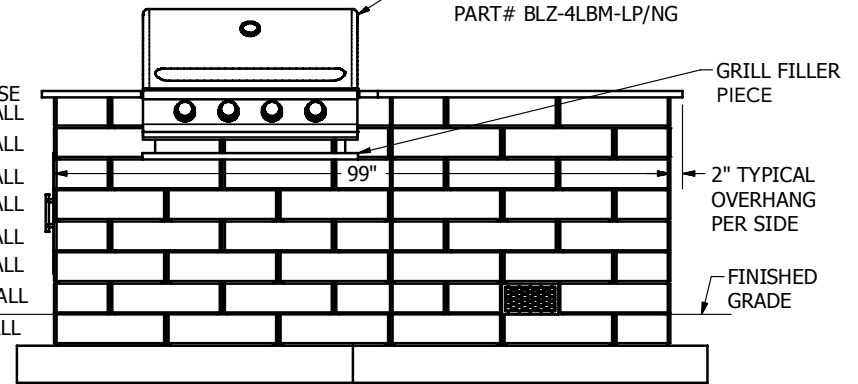

PRODUCT COUNTS:
(160) TOTAL WALL UNITS

LENZA - 45 x 99 L-SHAPE GRILL TOP - LEFT DOOR DESIGN

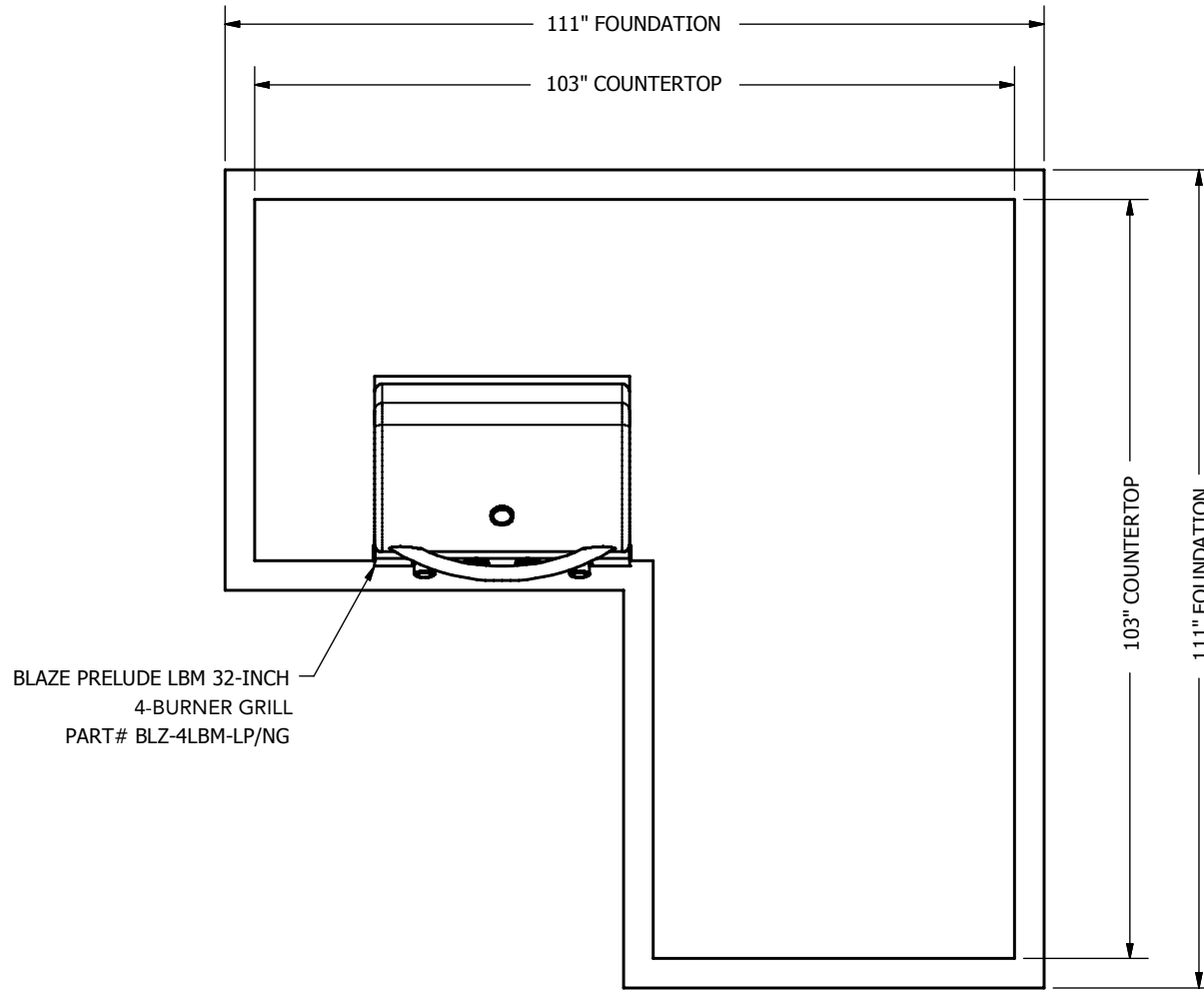

PLAN VIEW

LENZA - 45 x 99 L-SHAPE GRILL TOP - LEFT DOOR DESIGN

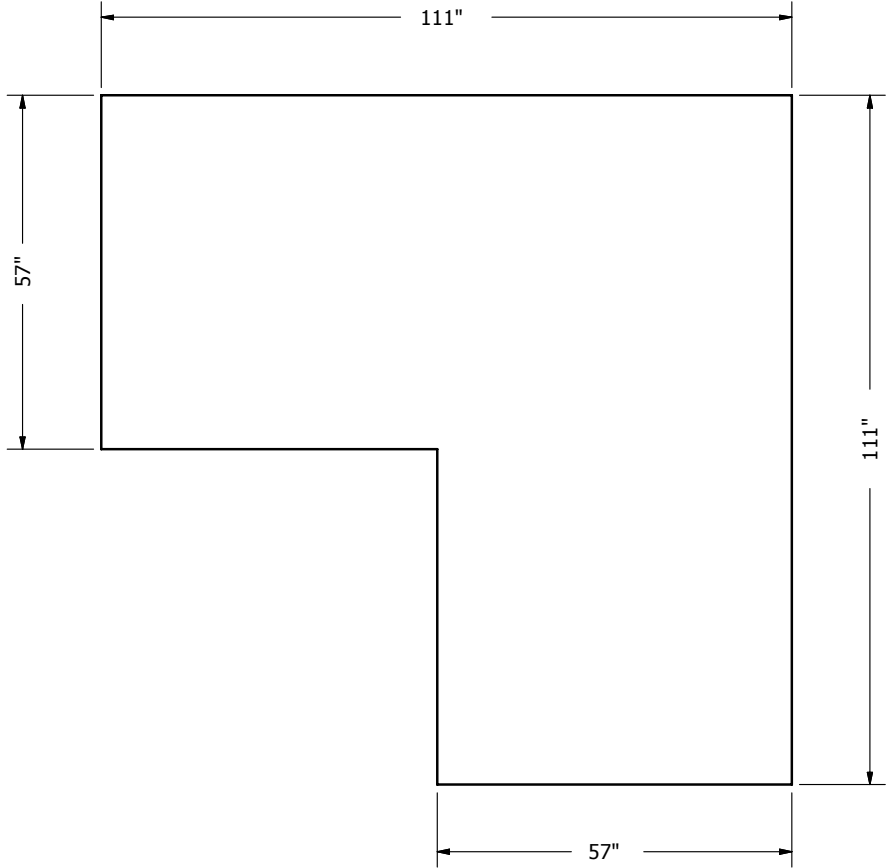

PLAN VIEW

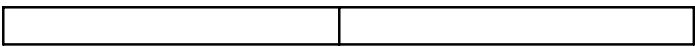

FRONT ELEVATION VIEW

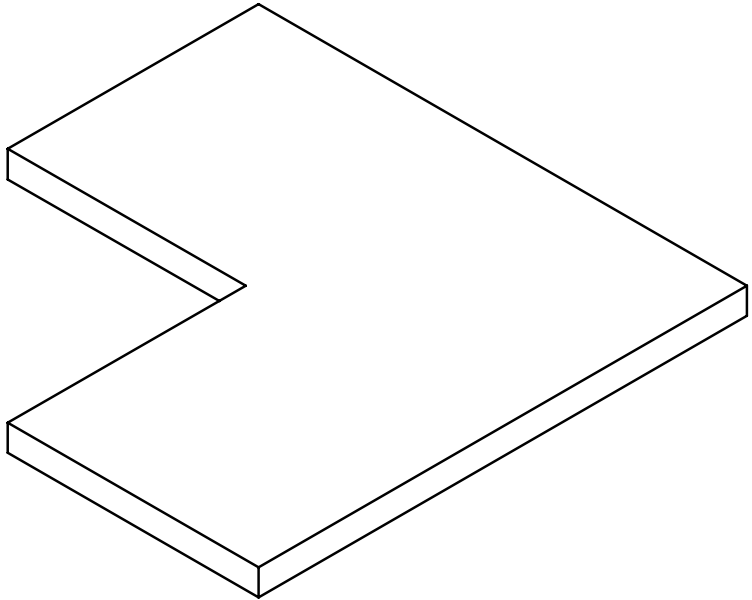

ISOMETRIC VIEW

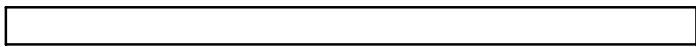

SIDE ELEVATION VIEW

CRUSHED STONE OR
REINFORCED CONCRETE
LEVELING PAD

LENZA - 45 x 99 L-SHAPE GRILL TOP - LEFT DOOR CUT DESIGN - FOUNDATION LEVELING PAD

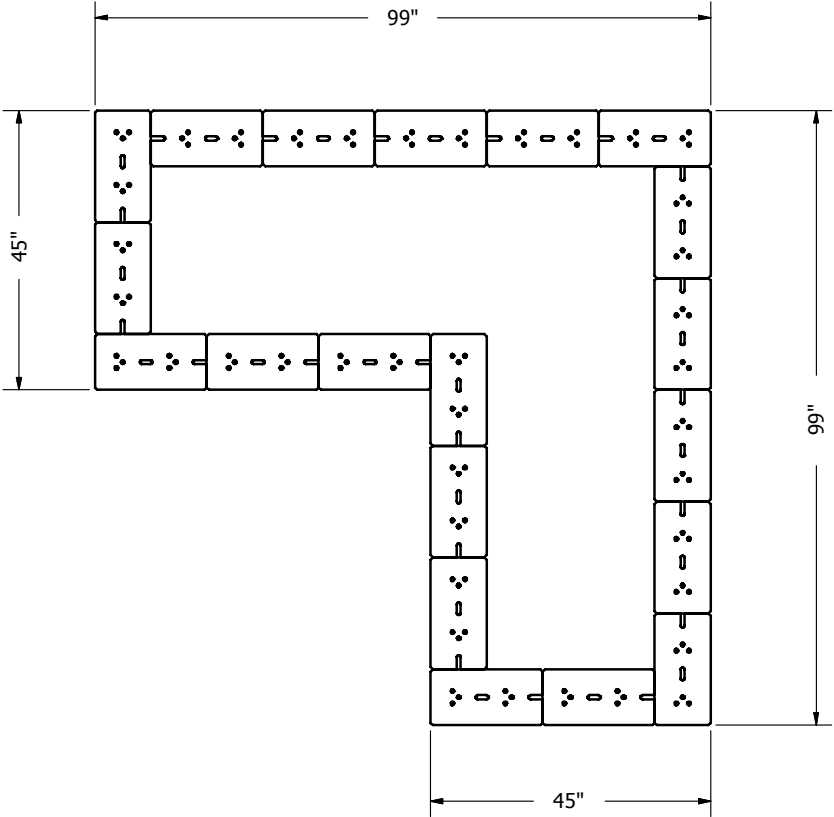

NOTE:
 1. WALL UNITS TO BE INSTALLED WITH CHANNEL ON THE BOTTOM SIDE
 (PRODUCT IS TO BE INVERTED 180 DEGREES FROM FINISHED PALLET).

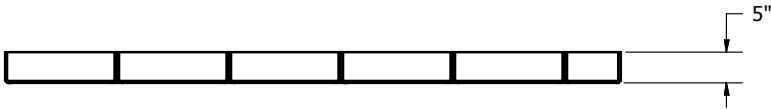
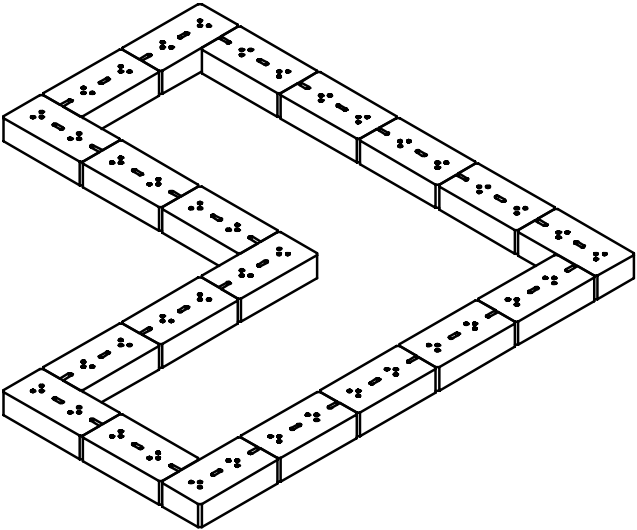

PRODUCT COUNTS:
 (20) TOTAL WALL UNITS

LENZA - 45 x 99 L-SHAPE GRILL TOP - LEFT DOOR CUT DESIGN - 1st COURSE

LENZA - 45 x 99 L-SHAPE GRILL TOP - LEFT DOOR DESIGN

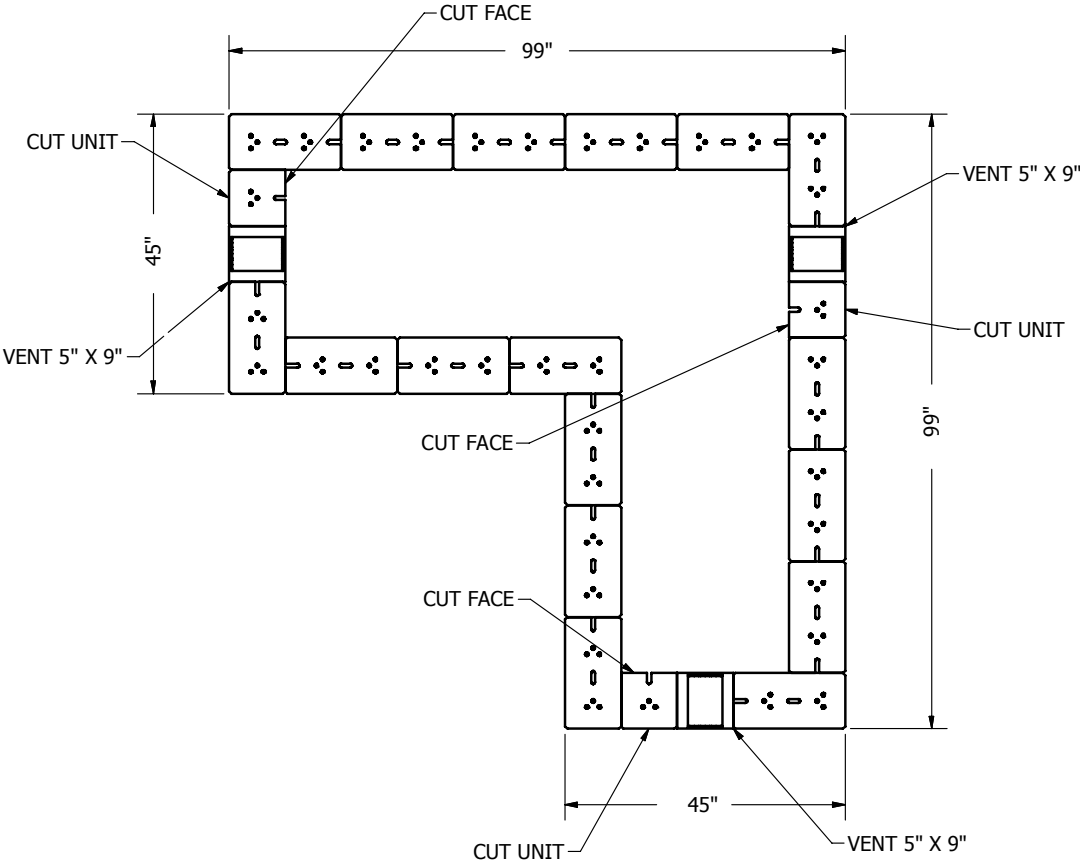

PLAN VIEW

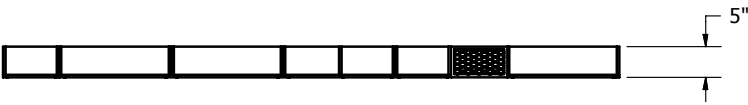

FRONT ELEVATION VIEW

NOTE:
1. WALL UNITS TO BE INSTALLED WITH CHANNEL ON THE BOTTOM SIDE
(PRODUCT IS TO BE INVERTED 180 DEGREES FROM FINISHED PALLET).

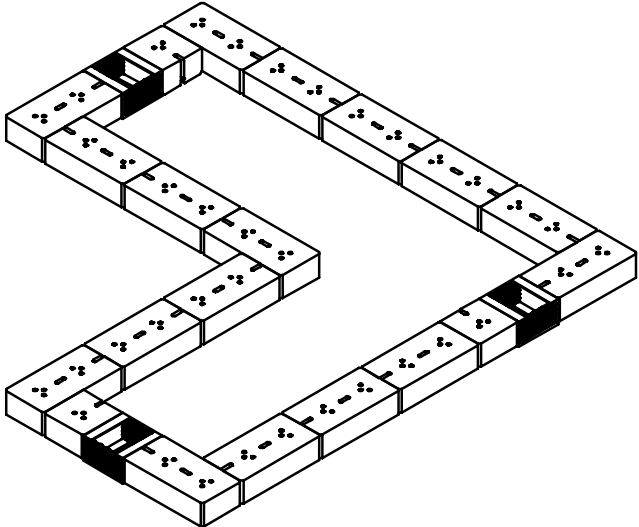

ISOMETRIC VIEW



SIDE ELEVATION VIEW

PRODUCT COUNTS:
(20) TOTAL WALL UNITS

LENZA - 45 x 99 L-SHAPE GRILL TOP - LEFT DOOR CUT DESIGN - 2nd COURSE

LENZA - 45 x 99 L-SHAPE GRILL TOP - LEFT DOOR DESIGN

NOTE:
 1. WALL UNITS TO BE INSTALLED WITH CHANNEL ON THE BOTTOM SIDE
 (PRODUCT IS TO BE INVERTED 180 DEGREES FROM FINISHED PALLET).

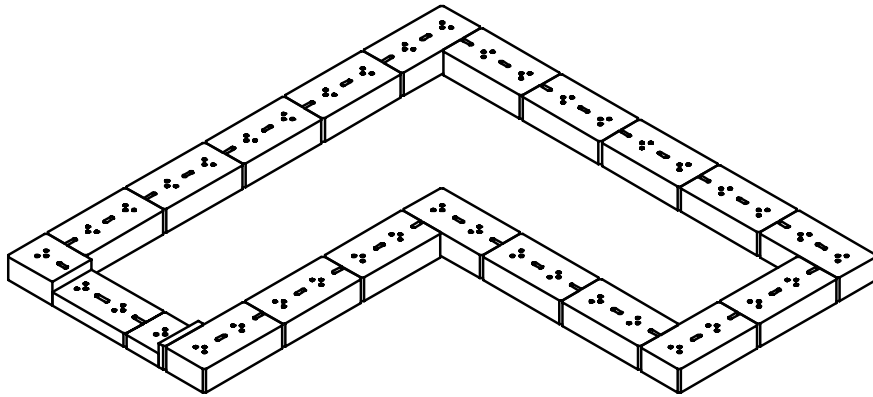

ISOMETRIC VIEW

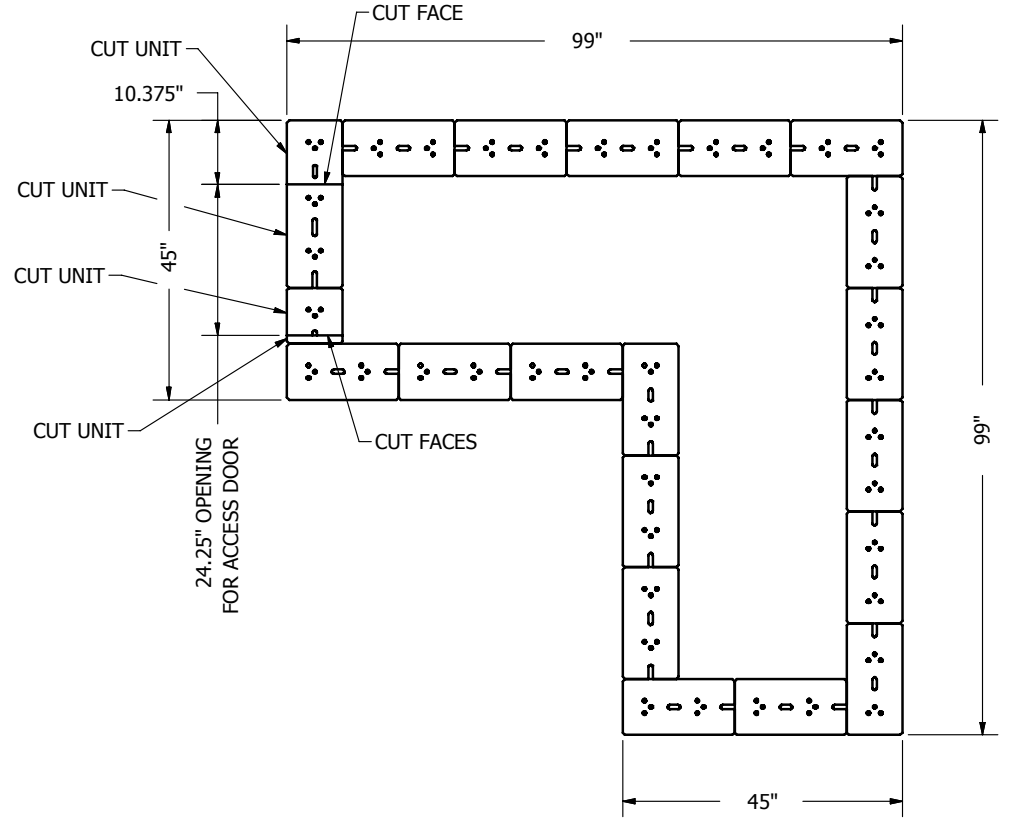

PLAN VIEW

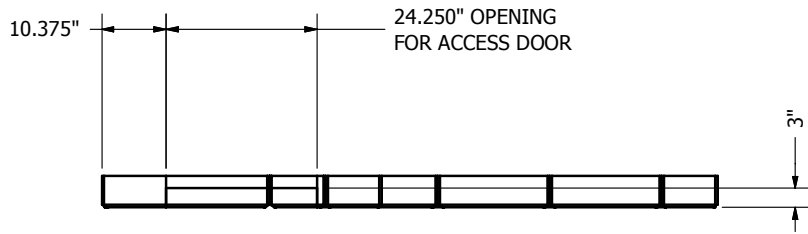

SIDE ELEVATION VIEW

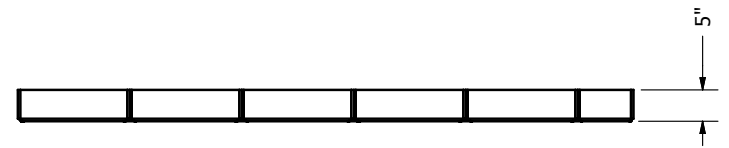

FRONT ELEVATION VIEW

LENZA - 45 x 99 L-SHAPE GRILL TOP - LEFT DOOR CUT DESIGN - 3rd COURSE

PRODUCT COUNTS:
 (22) TOTAL WALL UNITS

LENZA - 45 x 99 L-SHAPE GRILL TOP - LEFT DOOR DESIGN

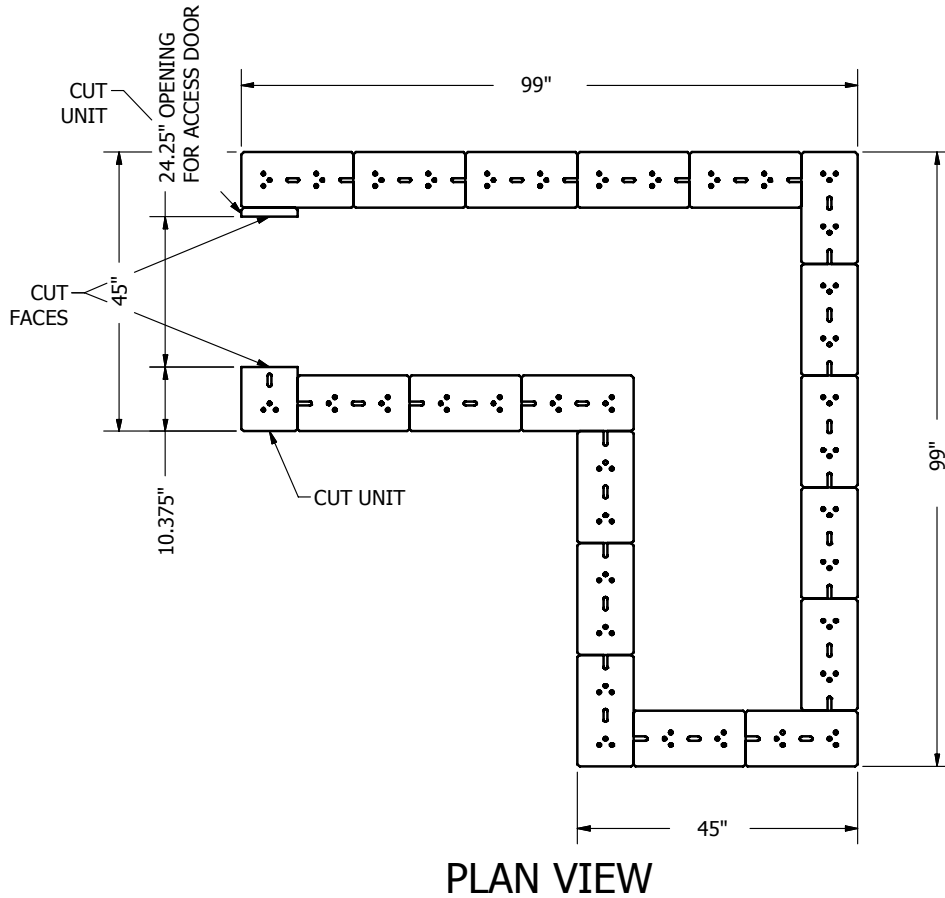

LENZA - 45 x 99 L-SHAPE GRILL TOP - LEFT DOOR CUT DESIGN - 4th AND 6th COURSES

NOTE:
 1. WALL UNITS TO BE INSTALLED WITH CHANNEL ON THE BOTTOM SIDE (PRODUCT IS TO BE INVERTED 180 DEGREES FROM FINISHED PALLET).

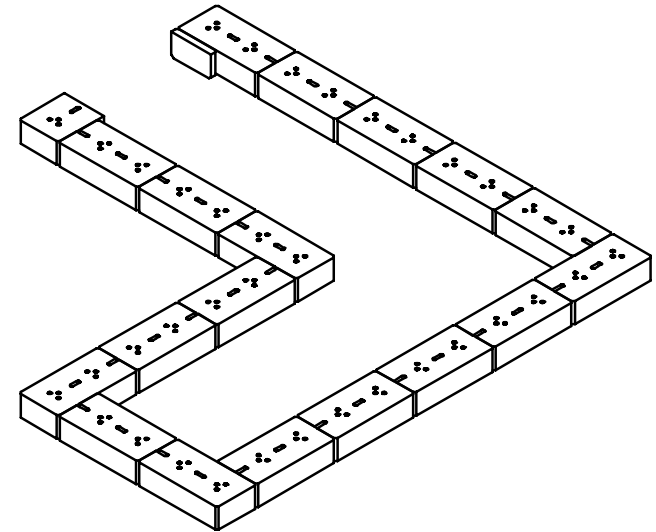

PRODUCT COUNTS:
 (20) TOTAL CAP UNITS

LENZA - 45 x 99 L-SHAPE GRILL TOP - LEFT DOOR DESIGN

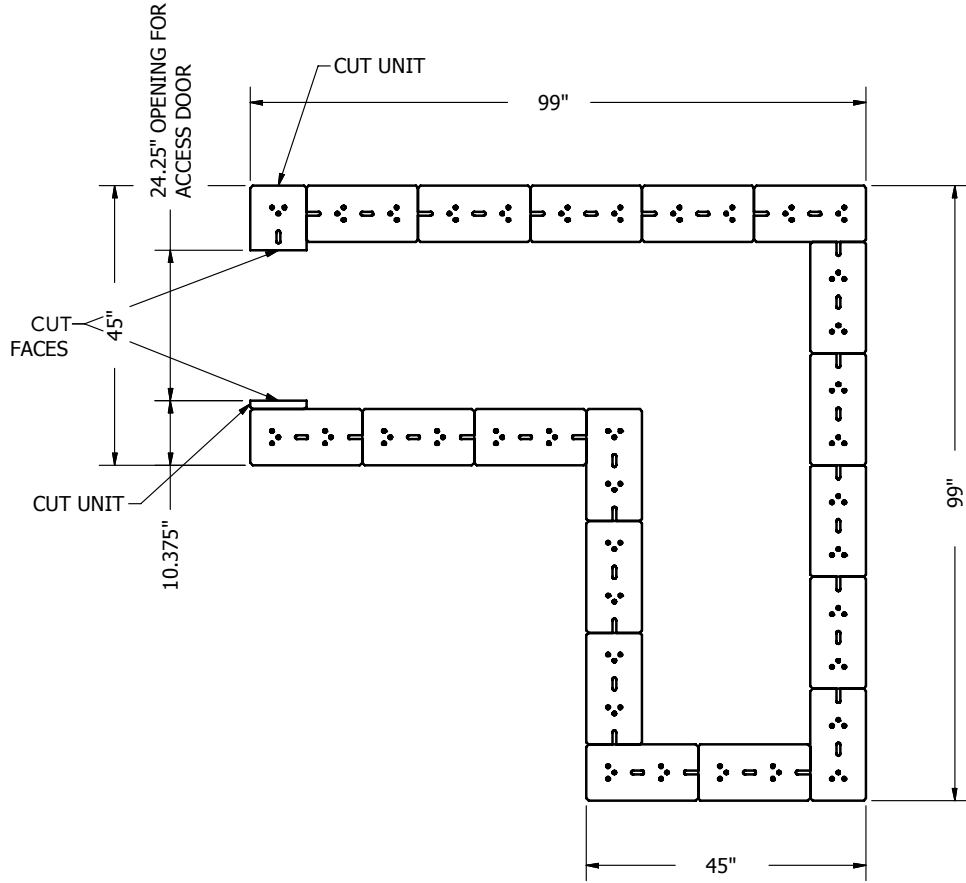

PLAN VIEW

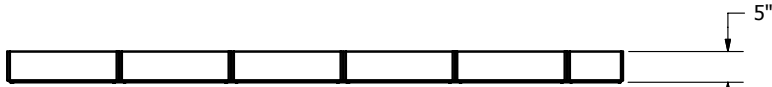

FRONT ELEVATION VIEW

NOTE:
 1. WALL UNITS TO BE INSTALLED WITH CHANNEL ON THE BOTTOM SIDE (PRODUCT IS TO BE INVERTED 180 DEGREES FROM FINISHED PALLET).

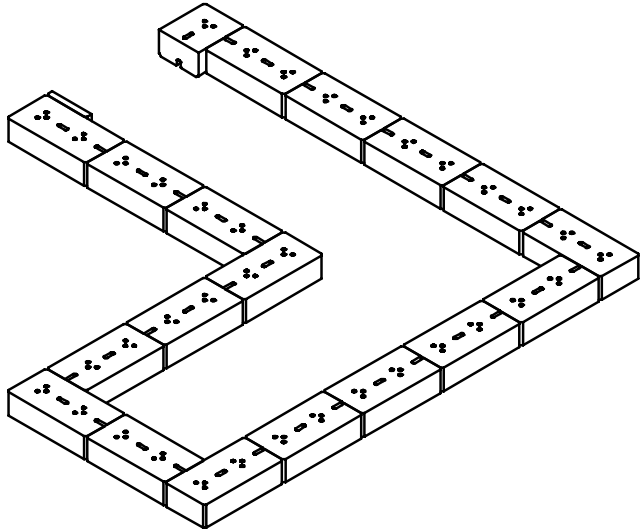

ISOMETRIC VIEW



SIDE ELEVATION VIEW

PRODUCT COUNTS:
 (20) TOTAL CAP UNITS

LENZA - 45 x 99 L-SHAPE GRILL TOP - LEFT DOOR CUT DESIGN - 5th COURSE

LENZA - 45 x 99 L-SHAPE GRILL TOP - LEFT DOOR DESIGN

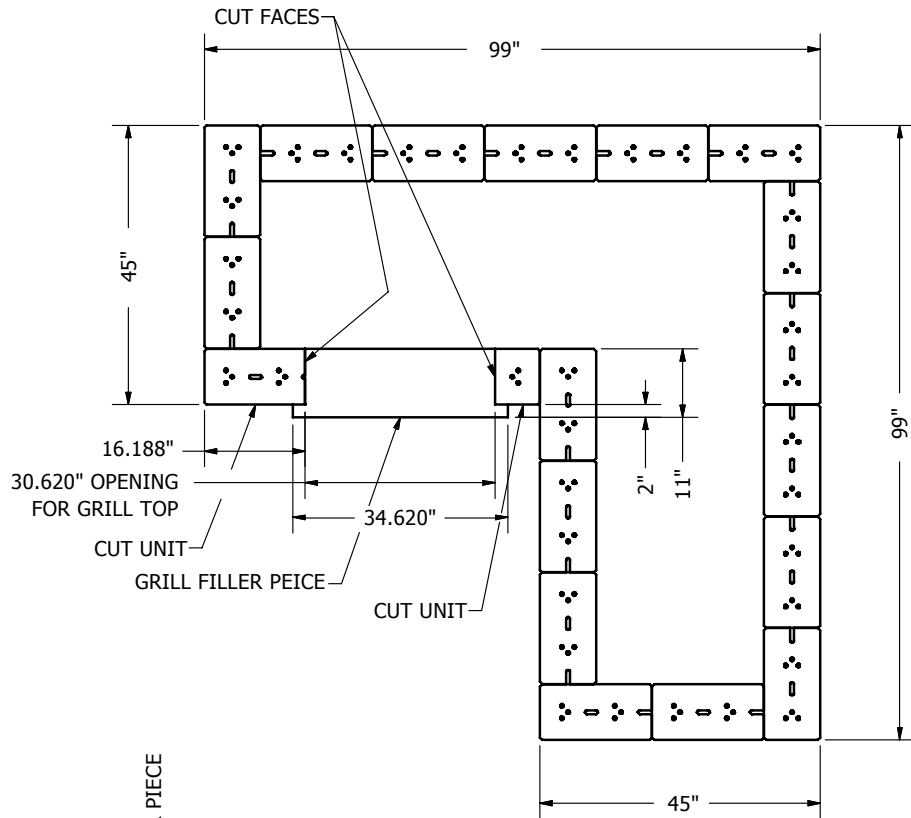

PLAN VIEW

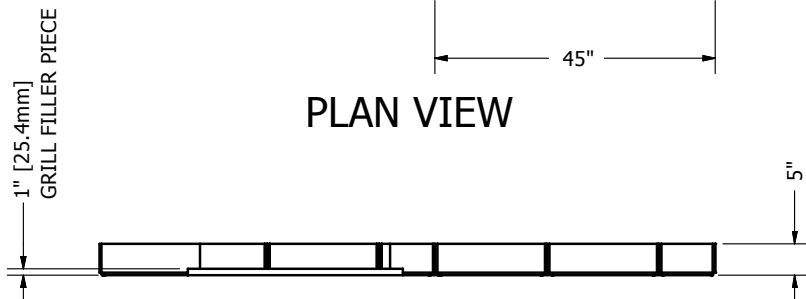

FRONT ELEVATION VIEW

NOTE:

1. WALL UNITS TO BE INSTALLED WITH CHANNEL ON THE BOTTOM SIDE (PRODUCT IS TO BE INVERTED 180 DEGREES FROM FINISHED PALLET).
2. GRILL FILLER PIECE IS TO BE MADE FROM THE SAME MATERIAL AS THE COUNTER TOP, (1" ± THICK).
3. UNLESS OTHERWISE DIRECTED INSTALL AND SECURE GRILL FILLER PIECE WITH APPROVED ADHESIVE OR BONDING AGENT.

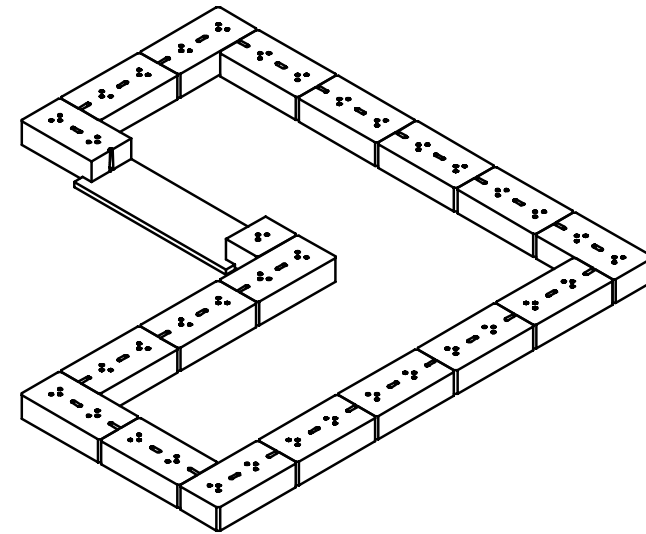

ISOMETRIC VIEW



SIDE ELEVATION VIEW

PRODUCT COUNTS:
(19) TOTAL WALL UNITS

LENZA - 45 x 99 L-SHADE GRILL TOP - LEFT DOOR CUT DESIGN - 7th COURSE

LENZA - 45 x 99 L-SHAPE GRILL TOP - LEFT DOOR DESIGN

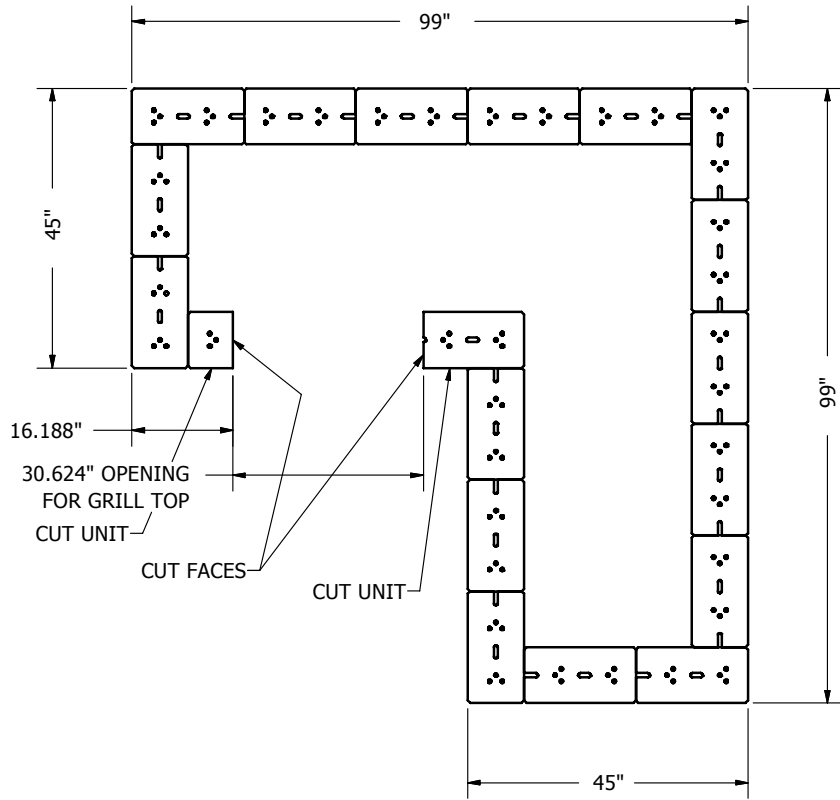

PLAN VIEW

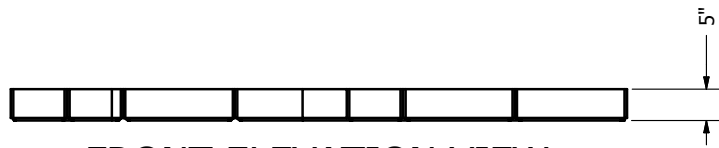

FRONT ELEVATION VIEW

NOTE:
1. WALL UNITS TO BE INSTALLED WITH CHANNEL ON THE BOTTOM SIDE
(PRODUCT IS TO BE INVERTED 180 DEGREES FROM FINISHED PALLET).

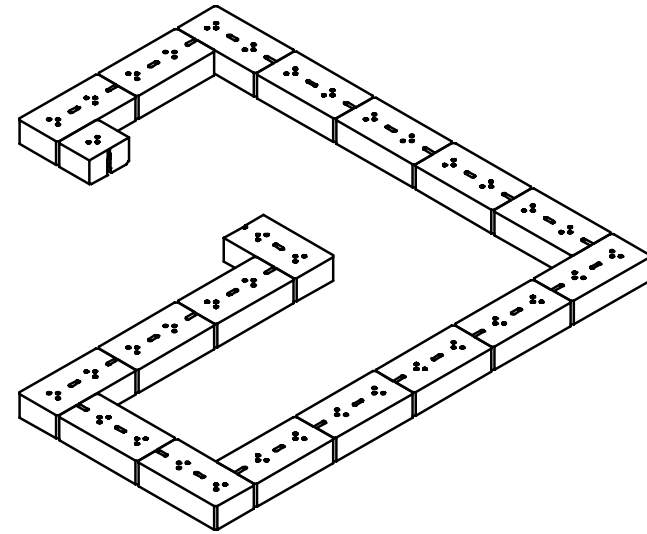

ISOMETRIC VIEW

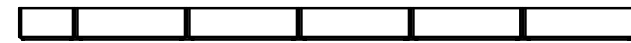

SIDE ELEVATION VIEW

PRODUCT COUNTS:
(19) TOTAL WALL UNITS

LENZA - 45 x 99 L-SHAPE GRILL TOP - LEFT DOOR CUT DESIGN - 8th COURSE

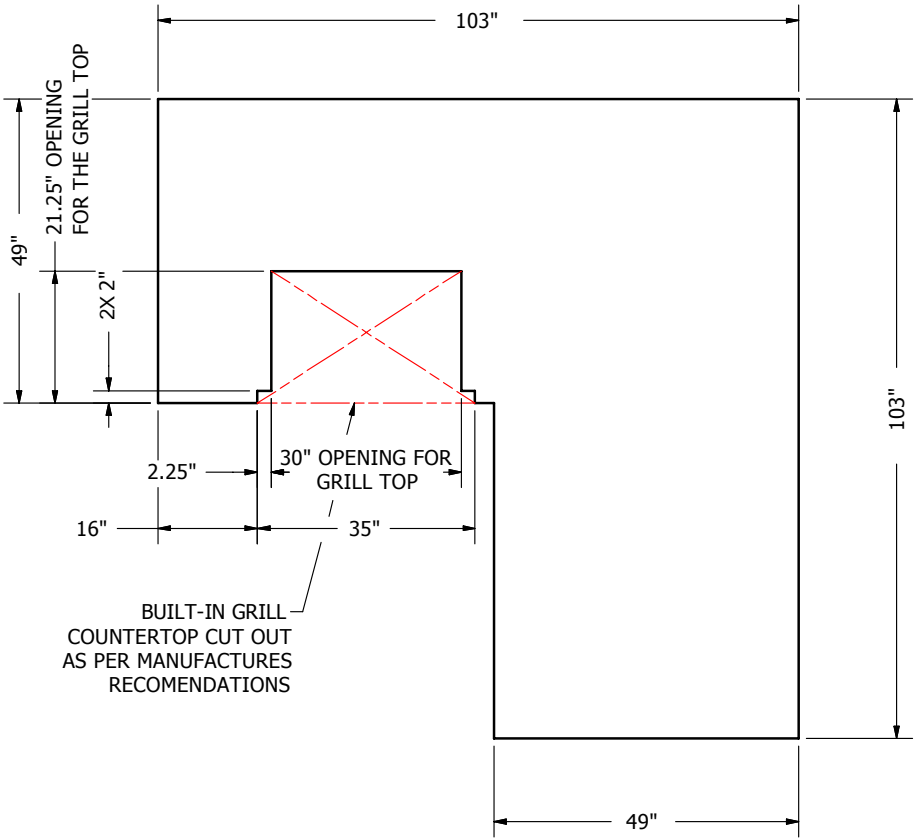

PLAN VIEW

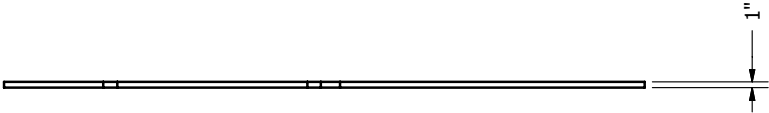

FRONT ELEVATION VIEW

NOTE:
1. UNLESS OTHERWISE DIRECTED INSTALL AND SECURE COUNTERTOP WITH APPROVED ADHESIVE OR BONDING AGENT.

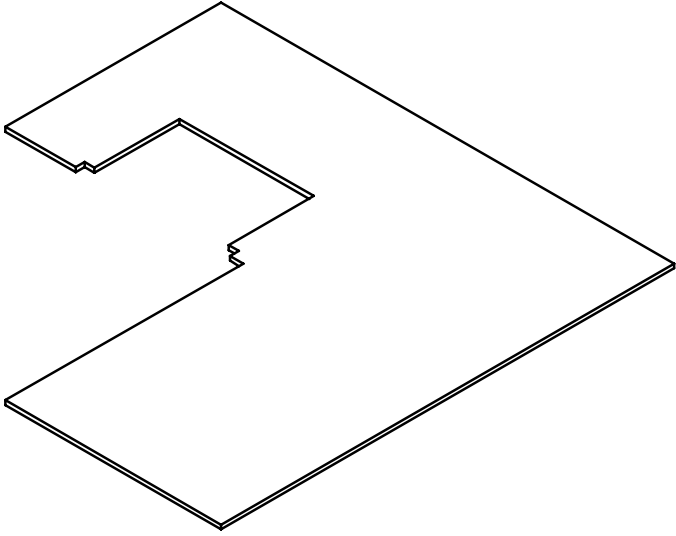

ISOMETRIC VIEW



SIDE ELEVATION VIEW

LENZA - 45 x 99 L-SHAPE GRILL TOP - LEFT DOOR CUT DESIGN - COUNTERTOP COURSE