

OUTDOOR LIVING DESIGNS

LENZA

LENZA - 27 INCH SQUARE FIREPIT

LENZA - 27 INCH SQUARE FIREPIT

OUTDOOR LIVING DESIGNS

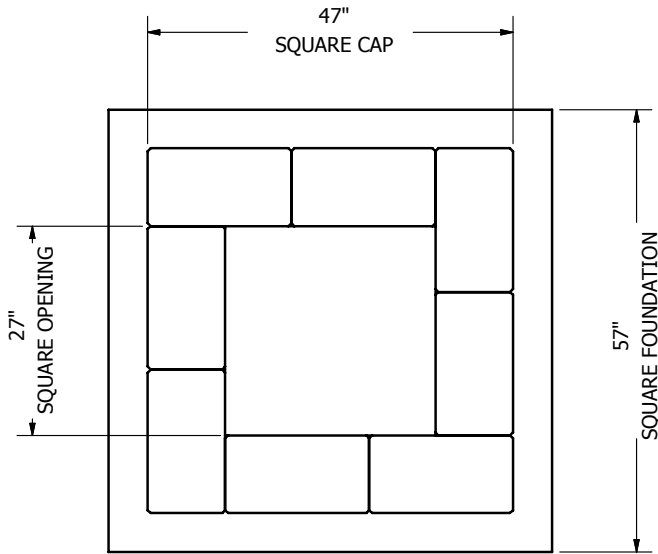

TOP VIEW

NOTE:

1. WALL UNITS TO BE INSTALLED WITH CHANNEL ON THE BOTTOM SIDE IN ORDER TO GET THE PROPER CONTEMPORARY ESTHETIC LOOK. (WALL PRODUCT TO BE INVERTED 180 DEGREES FROM FINISHED PALLET WHEN INSTALLED).
2. SECURE EACH UNIT USING APPROVED ADHESIVE OR BONDING AGENT FOLLOWING APPLICATION DIRECTIONS PROVIDED BY PRODUCT SUPPLIER.
3. ALL DIMENSIONS ARE IN INCHES.

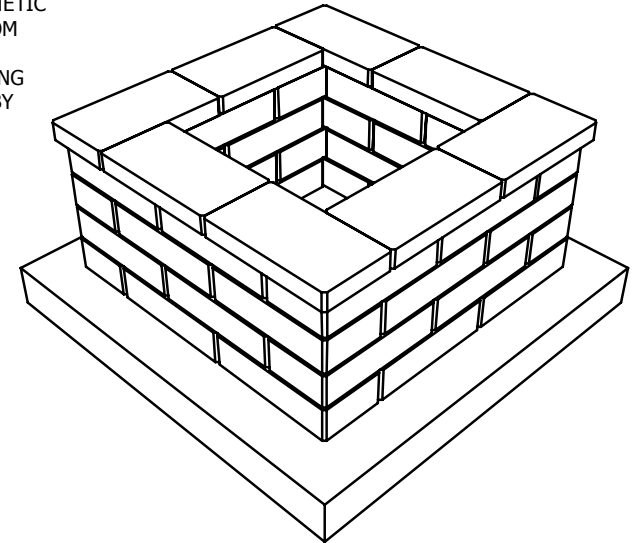

ISOMETRIC VIEW

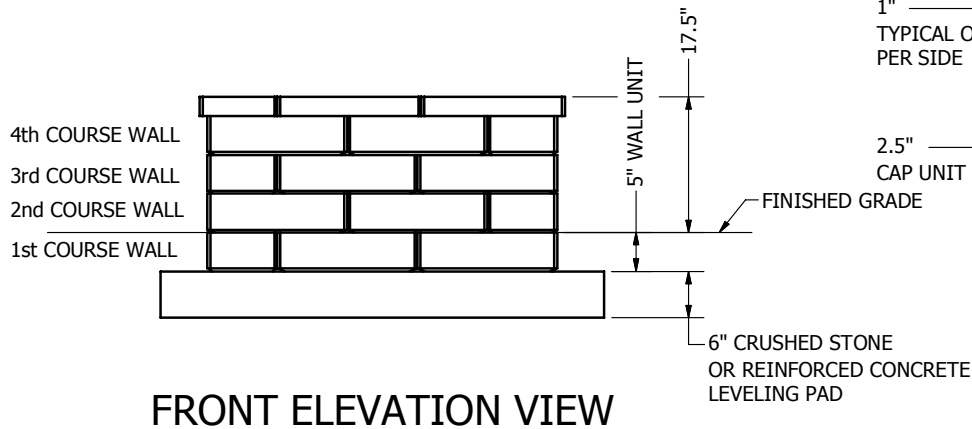

FRONT ELEVATION VIEW

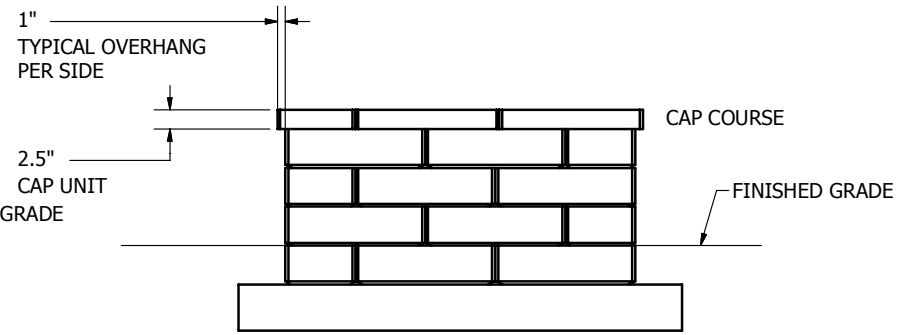

SIDE ELEVATION VIEW

PRODUCT COUNTS:
 (32) TOTAL WALL UNITS
 (8) TOTAL CAP UNITS

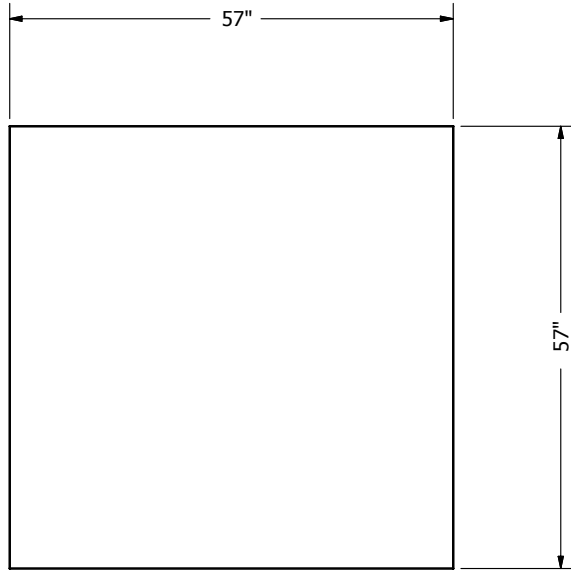

PLAN VIEW

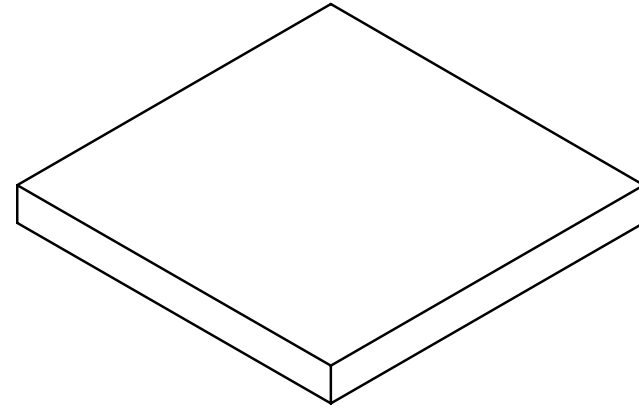

ISOMETRIC VIEW

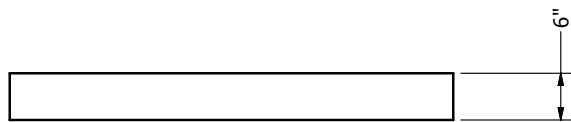

FRONT ELEVATION VIEW

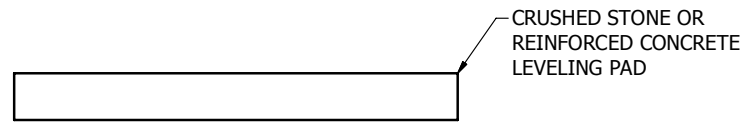

SIDE ELEVATION VIEW

LENZA 27 INCH SQUARE FIREPIT - FOUNDATION

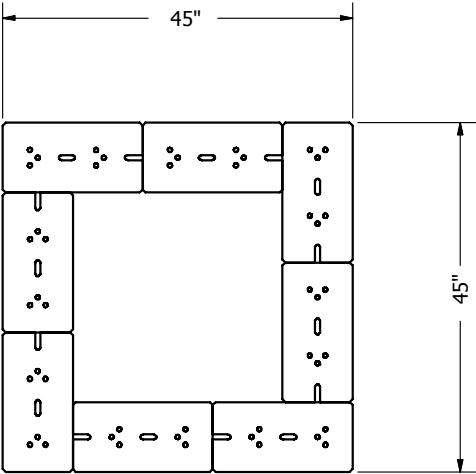

PLAN VIEW

NOTE:
1. WALL UNITS TO BE INSTALLED WITH CHANNEL ON THE BOTTOM SIDE
(PRODUCT IS TO BE INVERTED 180 DEGREES FROM FINISHED PALLET).

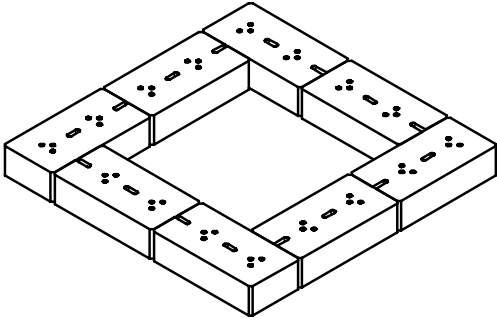

ISOMETRIC VIEW



FRONT ELEVATION VIEW



SIDE ELEVATION VIEW

PRODUCT COUNTS:
(8) TOTAL WALL UNITS

LENZA 27 INCH SQUARE FIREPIT - 1st, 3rd & 5th WALL COURSES

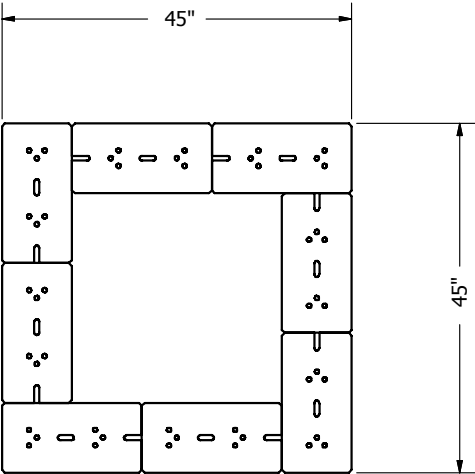

PLAN VIEW

NOTE:
1. WALL UNITS TO BE INSTALLED WITH CHANNEL ON THE BOTTOM SIDE
(PRODUCT IS TO BE INVERTED 180 DEGREES FROM FINISHED PALLET).

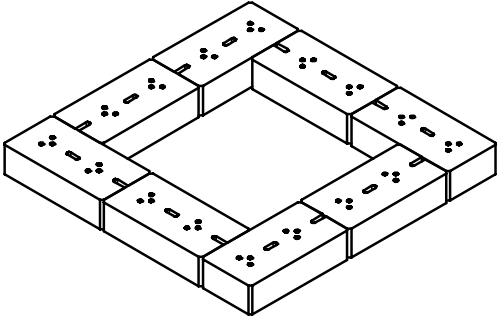

ISOMETRIC VIEW



FRONT ELEVATION VIEW



SIDE ELEVATION VIEW

PRODUCT COUNTS:
(8) TOTAL WALL UNITS

LENZA 27 INCH SQUARE FIREPIT - 2nd, 4th & 6th WALL COURSES

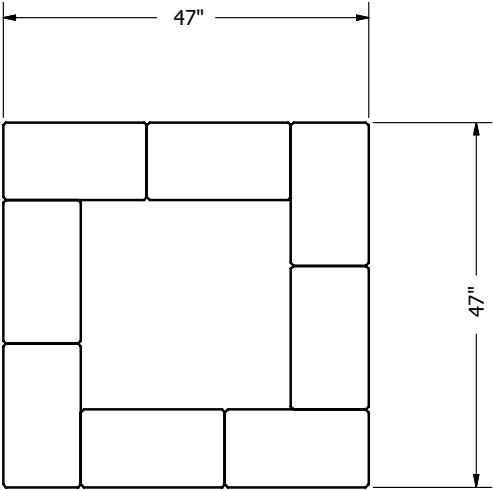

PLAN VIEW

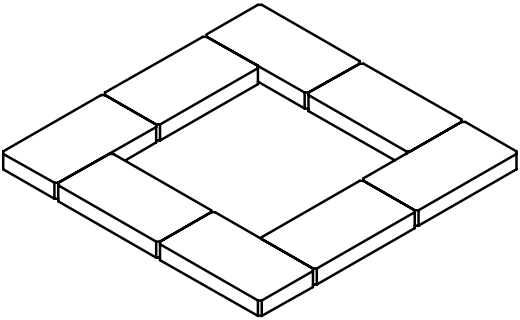

ISOMETRIC VIEW

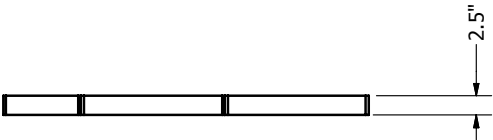

FRONT ELEVATION VIEW

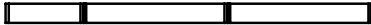

SIDE ELEVATION VIEW

PRODUCT COUNTS:
(8) TOTAL CAP UNITS

LENZA 27 INCH SQUARE FIREPIT - CAP COURSE