

OUTDOOR LIVING DESIGNS

LENZA

63 x 117 FIREPLACE - RIGHT ACCESS DOOR DESIGN

LENZA - 63 x 117 FIREPLACE - RIGHT ACCESS DOOR DESIGN

OUTDOOR LIVING DESIGNS

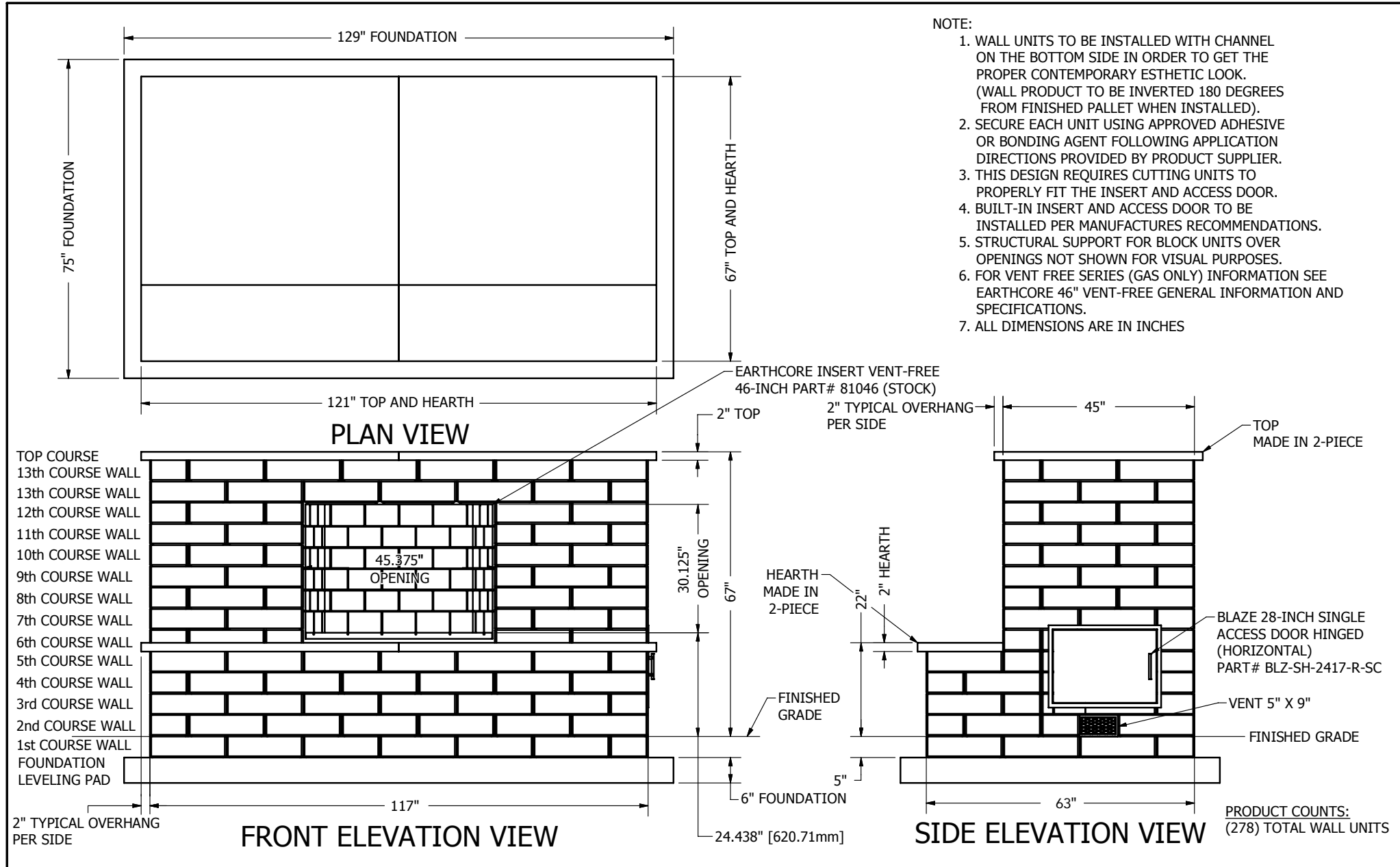

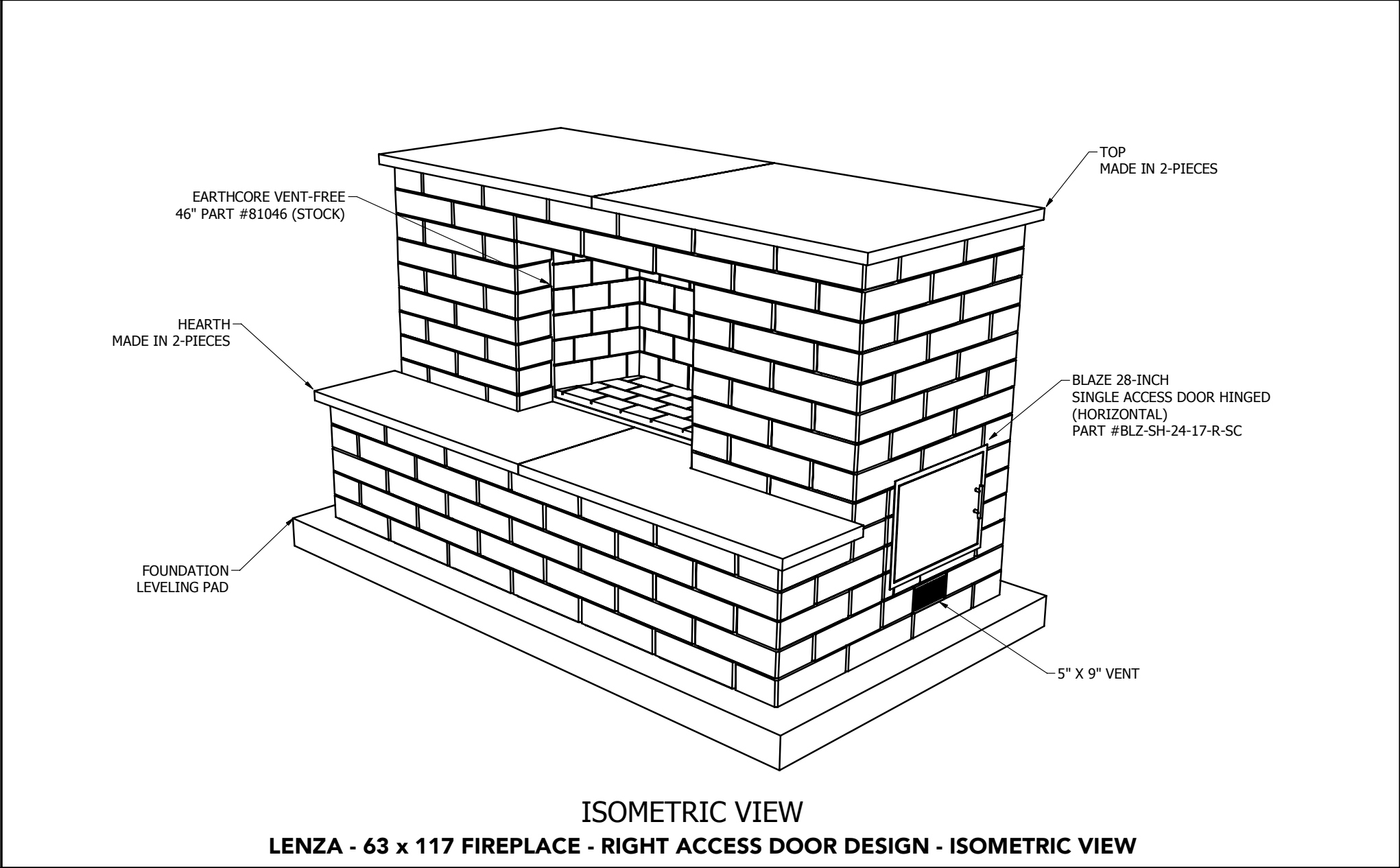

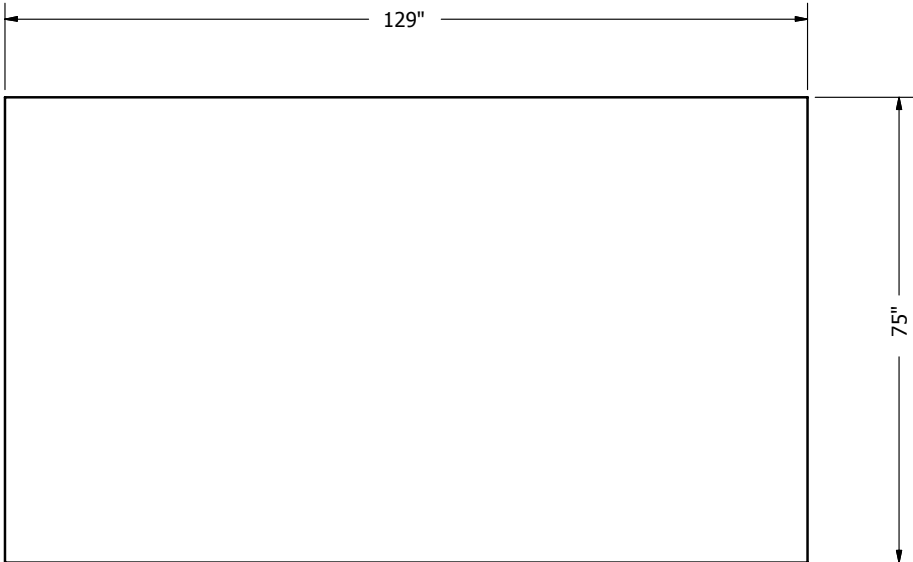

PLAN VIEW

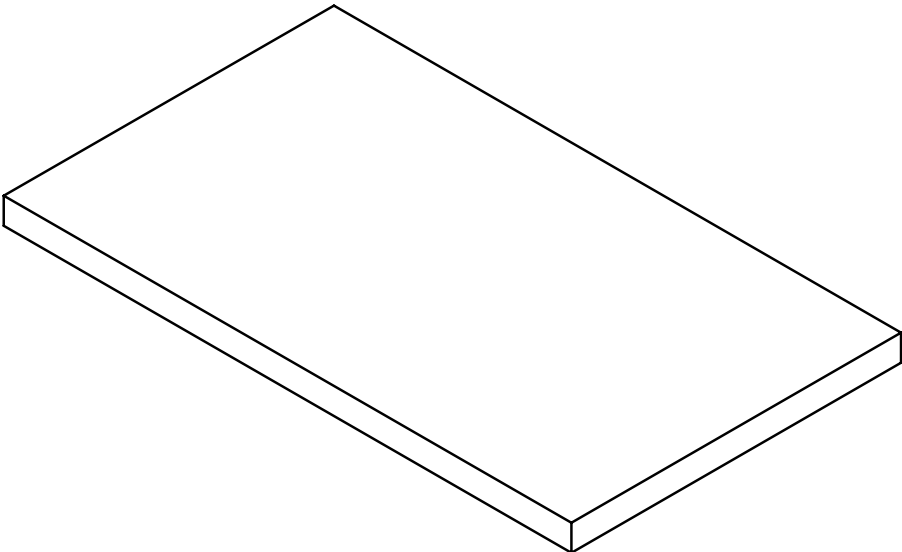

ISOMETRIC VIEW

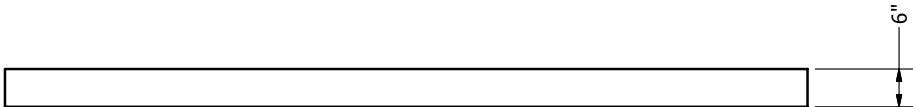

FRONT ELEVATION VIEW

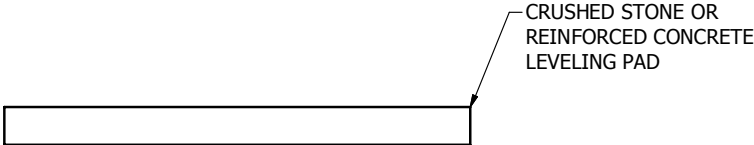

SIDE ELEVATION VIEW

CRUSHED STONE OR
REINFORCED CONCRETE
LEVELING PAD

LENZA - 63 x 117 FIREPLACE - RIGHT ACCESS DOOR DESIGN - FOUNDATION LEVELING PAD

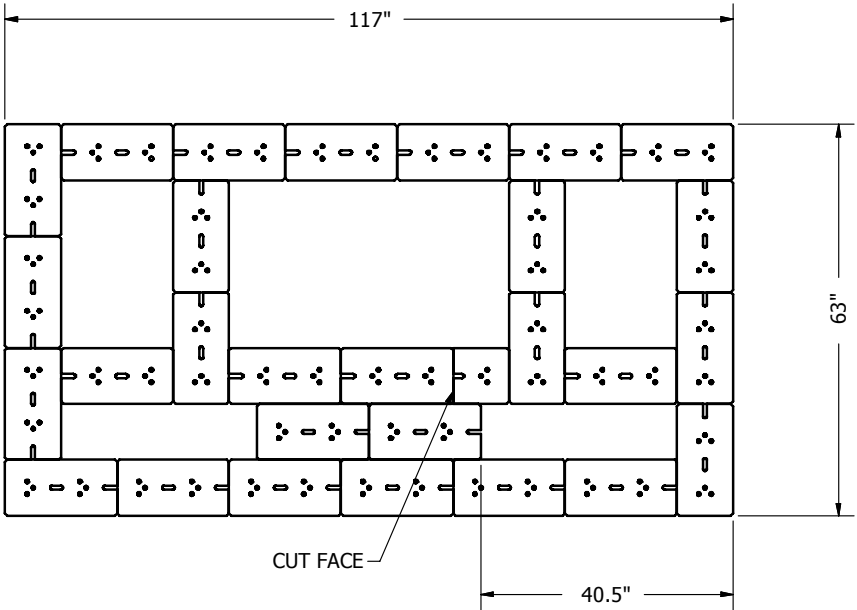

PLAN VIEW

NOTE:
 1. WALL UNITS TO BE INSTALLED WITH CHANNEL ON THE BOTTOM SIDE
 (PRODUCT IS TO BE INVERTED 180 DEGREES FROM FINISHED PALLET).

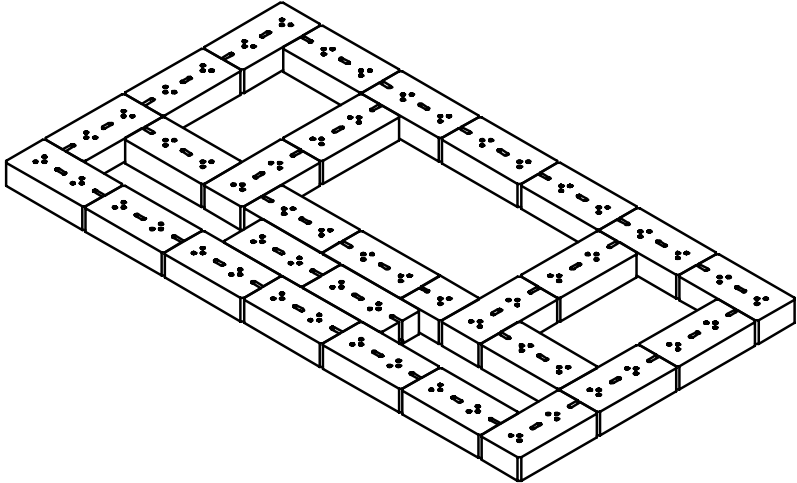

ISOMETRIC VIEW

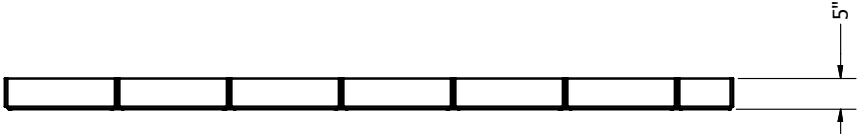

FRONT ELEVATION VIEW



SIDE ELEVATION VIEW

LENZA - 63 x 117 FIREPLACE - RIGHT ACCESS DOOR DESIGN - 1st COURSE

PRODUCT COUNTS:
 (28) TOTAL WALL UNITS

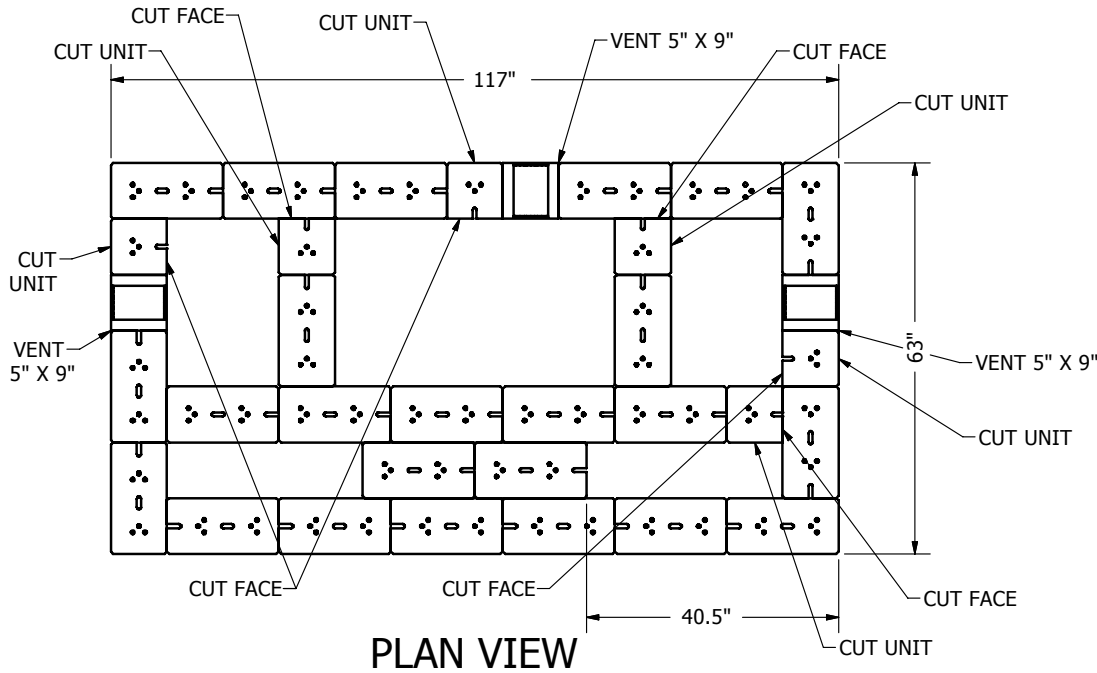

PLAN VIEW

NOTE:
1. WALL UNITS TO BE INSTALLED WITH CHANNEL ON THE BOTTOM SIDE (PRODUCT IS TO BE INVERTED 180 DEGREES FROM FINISHED PALLET).

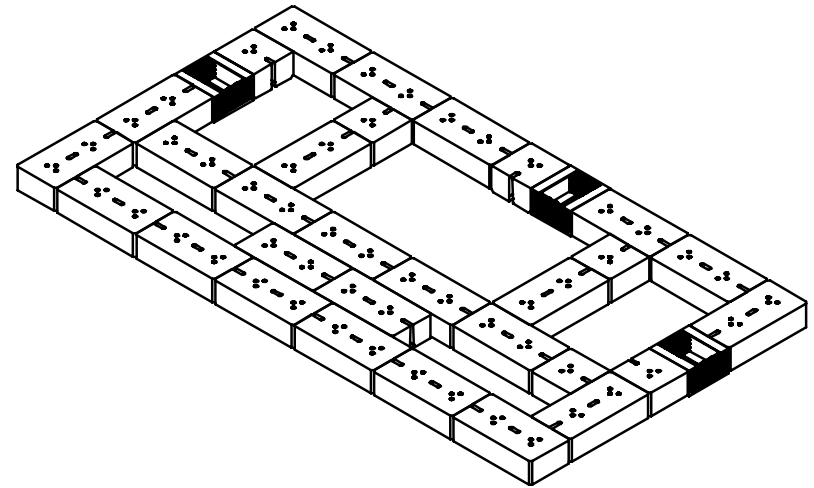

ISOMETRIC VIEW

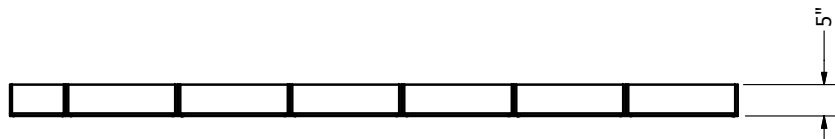

FRONT ELEVATION VIEW



SIDE ELEVATION VIEW

PRODUCT COUNTS:
(30) TOTAL WALL UNITS

LENZA - 63 x 117 FIREPLACE - RIGHT ACCESS DOOR DESIGN - 2nd COURSE

LENZA - 63 x 117 FIREPLACE - RIGHT ACCESS DOOR DESIGN

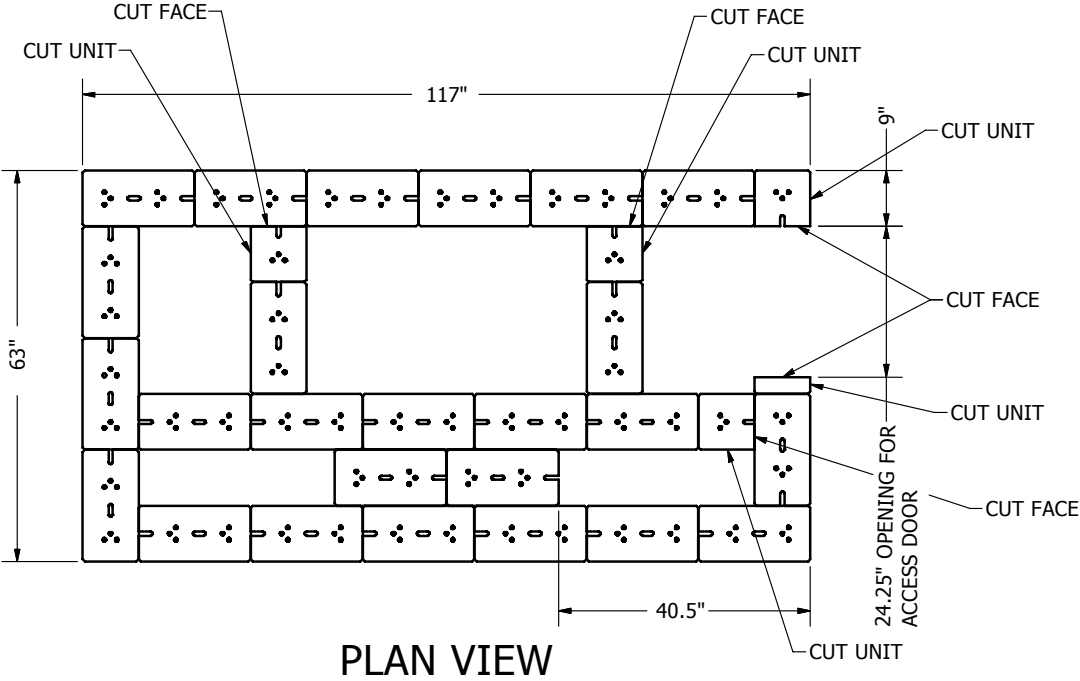

PLAN VIEW

NOTE:
 1. WALL UNITS TO BE INSTALLED WITH CHANNEL ON THE BOTTOM SIDE (PRODUCT IS TO BE INVERTED 180 DEGREES FROM FINISHED PALLET).

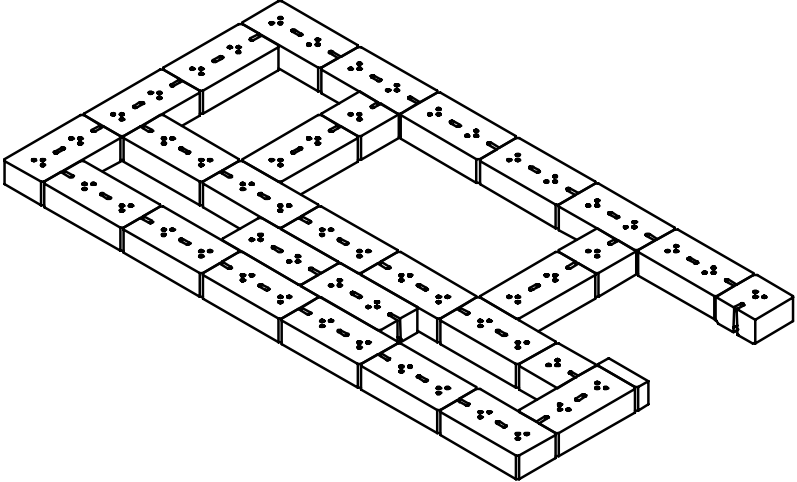

ISOMETRIC VIEW

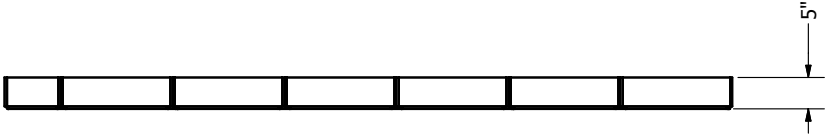

FRONT ELEVATION VIEW



SIDE ELEVATION VIEW

PRODUCT COUNTS:
 (30) TOTAL WALL UNITS

LENZA - 63 x 117 FIREPLACE - RIGHT ACCESS DOOR DESIGN - 4th COURSE

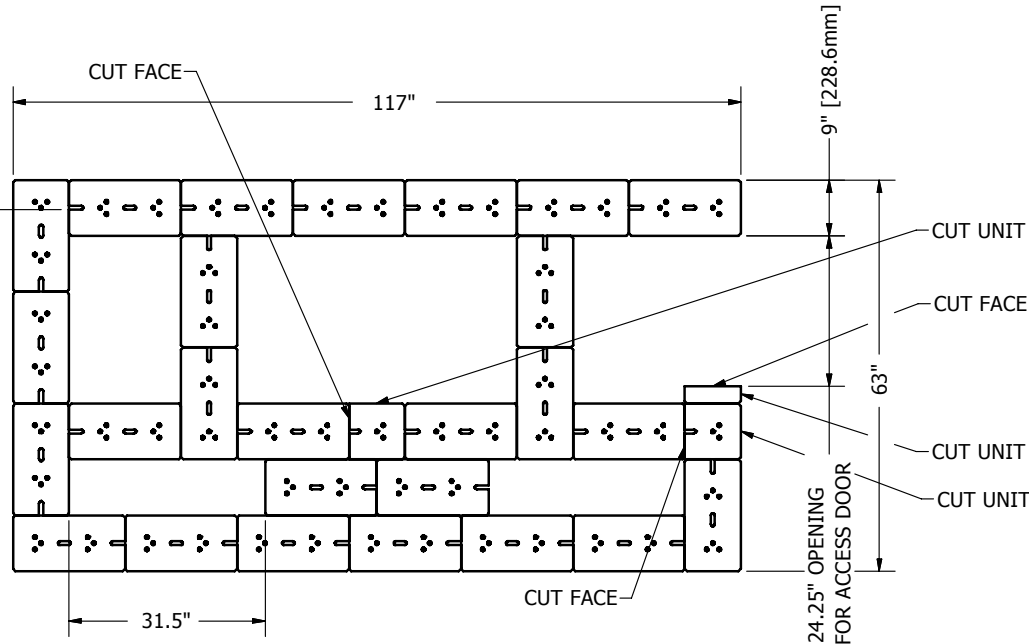

PLAN VIEW

NOTE:
 1. WALL UNITS TO BE INSTALLED WITH CHANNEL ON THE BOTTOM SIDE
 (PRODUCT IS TO BE INVERTED 180 DEGREES FROM FINISHED PALLET).

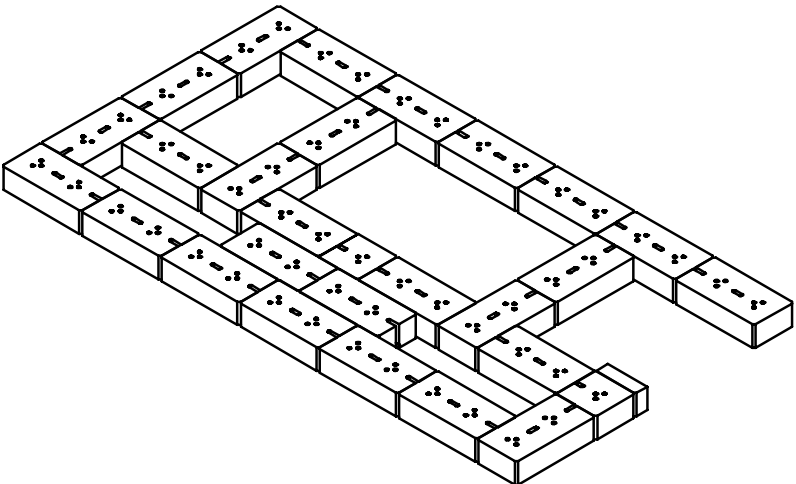

ISOMETRIC VIEW

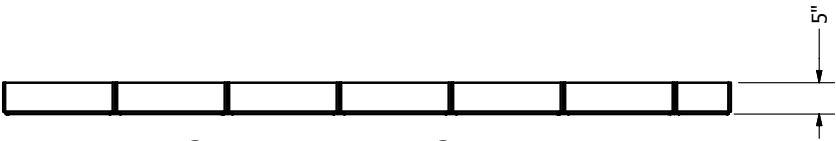

FRONT ELEVATION VIEW

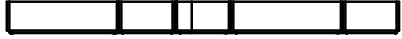

SIDE ELEVATION VIEW

LENZA - 63 x 117 FIREPLACE - RIGHT ACCESS DOOR DESIGN - 5th COURSE

PRODUCT COUNTS:
 (29) TOTAL CAP UNITS

LENZA - 63 x 117 FIREPLACE - RIGHT ACCESS DOOR DESIGN

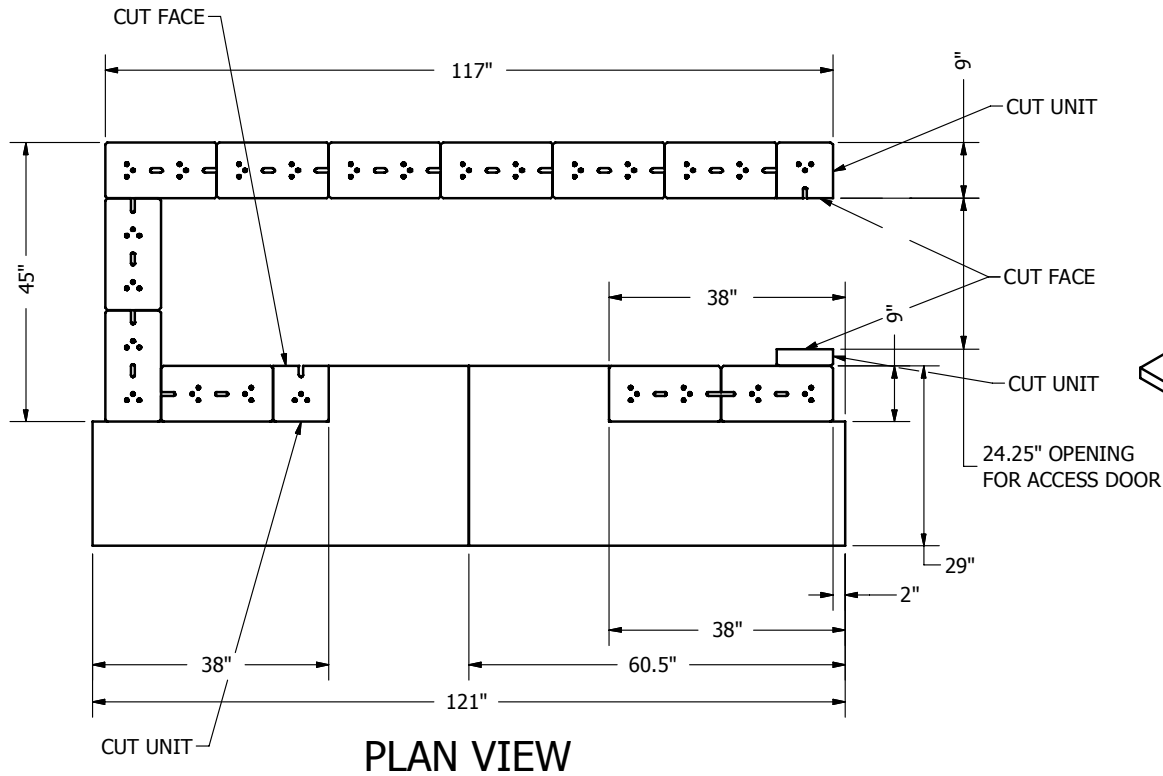

- NOTE:
1. WALL UNITS TO BE INSTALLED WITH CHANNEL ON THE BOTTOM SIDE (PRODUCT IS TO BE INVERTED 180 DEGREES FROM FINISHED PALLET).
 2. HEARTH PIECE IS TO BE MADE FROM THE SAME MATERIAL AS THE TOP, (2" ± THICK).
 3. UNLESS OTHERWISE DIRECTED INSTALL AND SECURE HEARTH PIECES WITH APPROVED ADHESIVE OR BONDING AGENT.

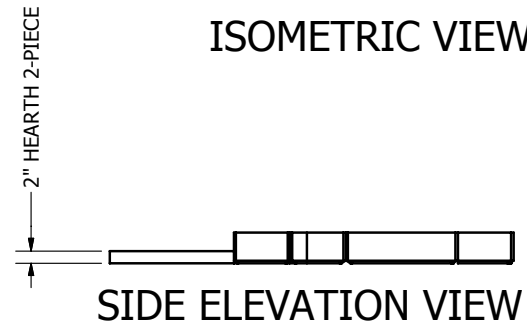
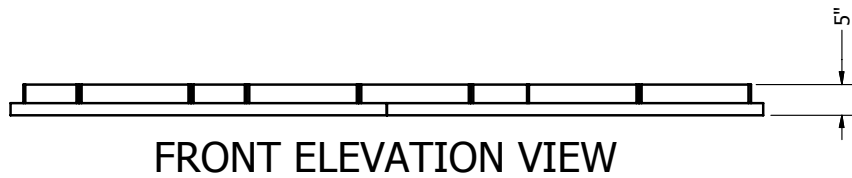
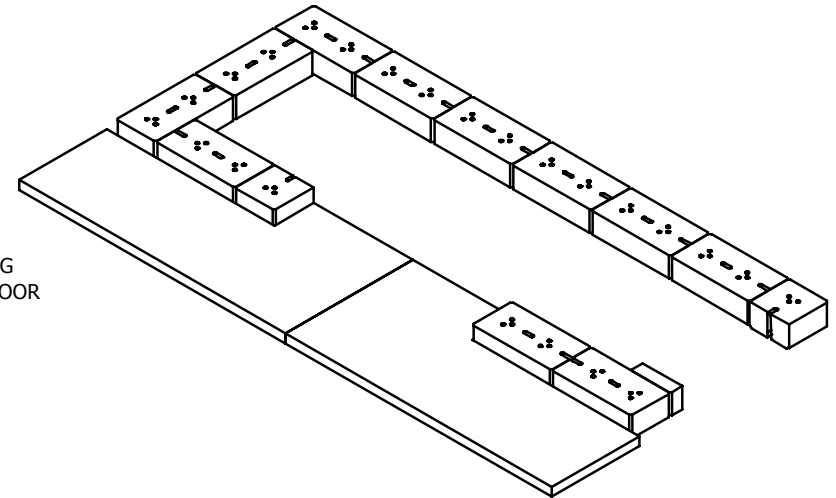

PRODUCT COUNTS:
(14) TOTAL CAP UNITS

LENZA - 63 x 117 FIREPLACE - RIGHT ACCESS DOOR DESIGN - 6th COURSE

NOTE:
1. WALL UNITS TO BE INSTALLED WITH CHANNEL ON THE BOTTOM SIDE
(PRODUCT IS TO BE INVERTED 180 DEGREES FROM FINISHED PALLET).

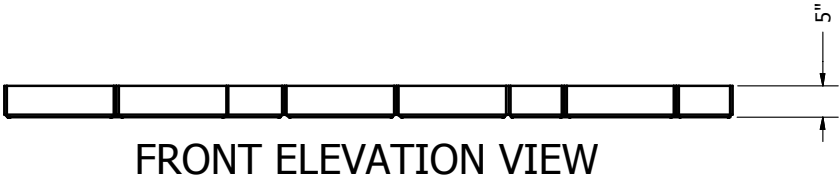
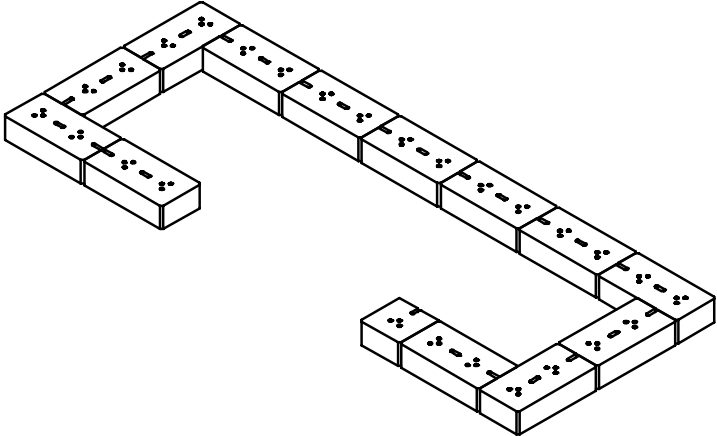
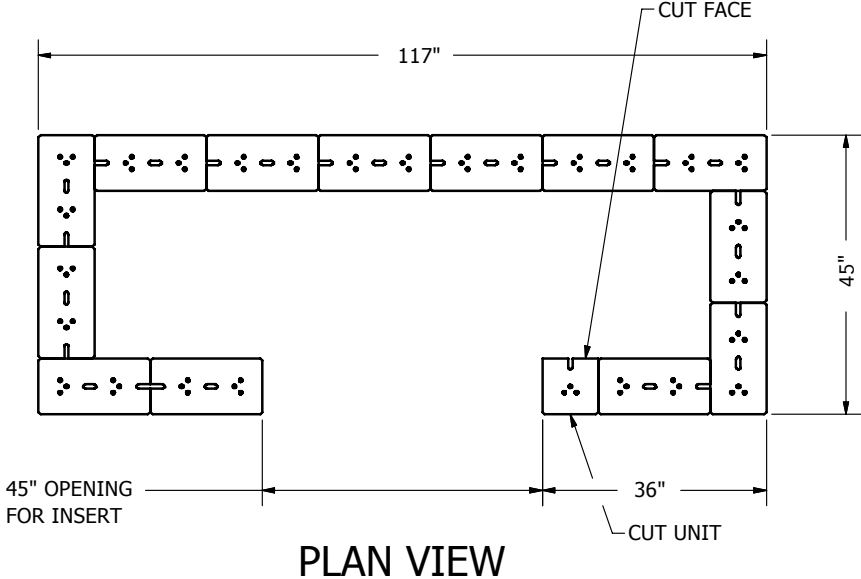

PRODUCT COUNTS:
(14) TOTAL WALL UNITS

LENZA - 63 x 117 FIREPLACE - RIGHT ACCESS DOOR DESIGN - 7th, 9th & 11th COURSES

NOTE:
1. WALL UNITS TO BE INSTALLED WITH CHANNEL ON THE BOTTOM SIDE
(PRODUCT IS TO BE INVERTED 180 DEGREES FROM FINISHED PALLET).

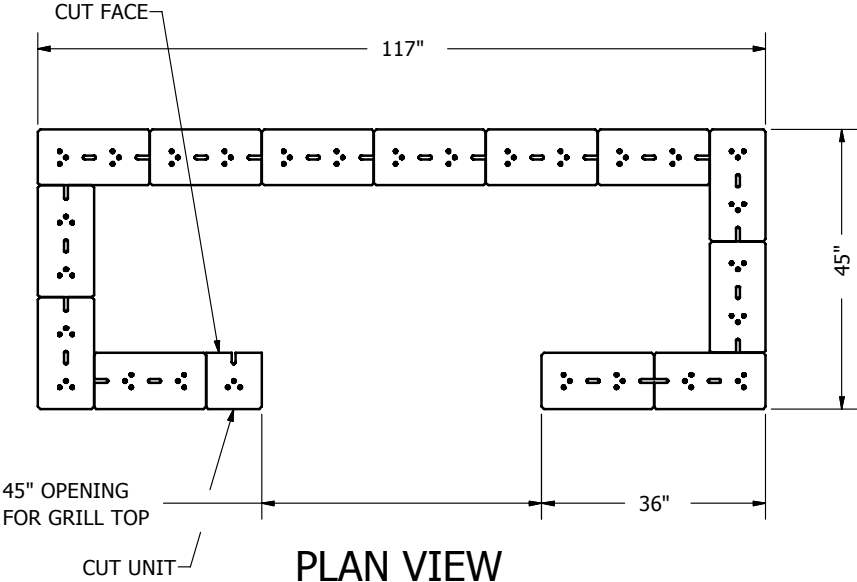

PLAN VIEW

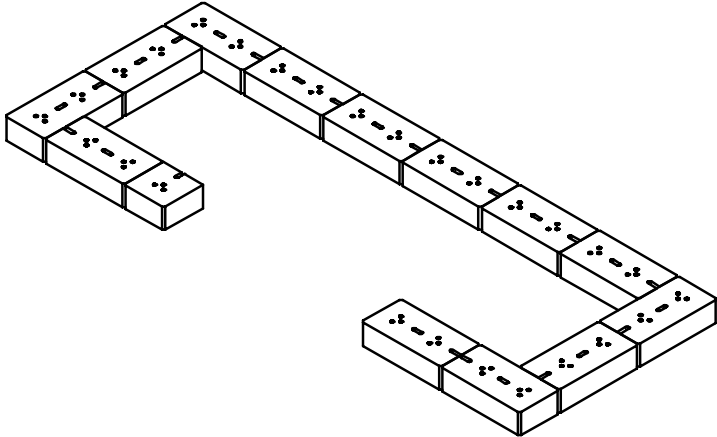

ISOMETRIC VIEW

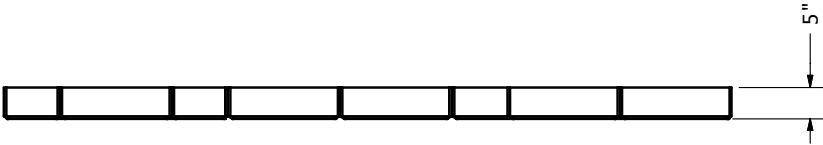

FRONT ELEVATION VIEW



SIDE ELEVATION VIEW

PRODUCT COUNTS:
(14) TOTAL WALL UNITS

LENZA - 63 x 117 FIREPLACE - RIGHT ACCESS DOOR DESIGN - 8th, 10th & 12th COURSES

NOTE:
1. WALL UNITS TO BE INSTALLED WITH CHANNEL ON THE BOTTOM SIDE
(PRODUCT IS TO BE INVERTED 180 DEGREES FROM FINISHED PALLET).

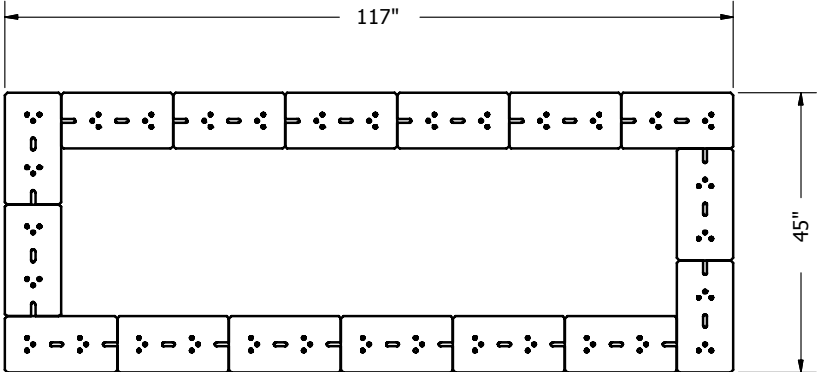

PLAN VIEW

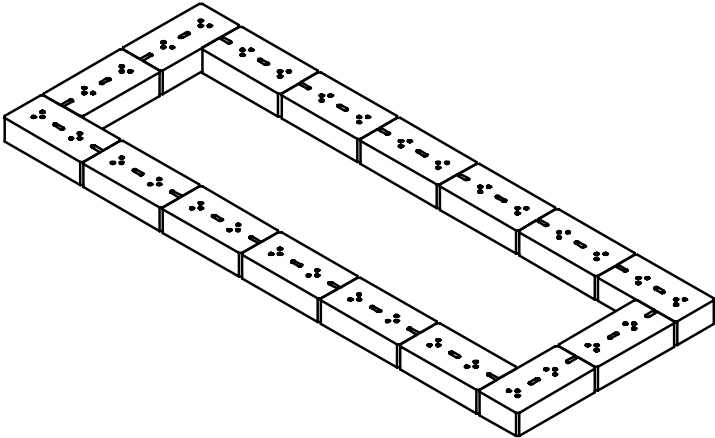

ISOMETRIC VIEW

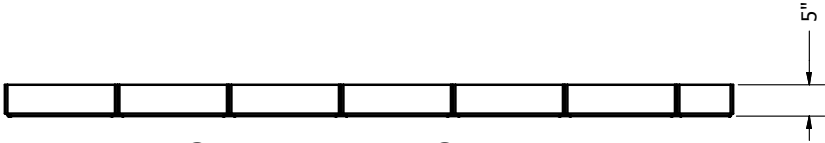

FRONT ELEVATION VIEW

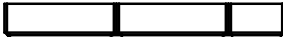

SIDE ELEVATION VIEW

PRODUCT COUNTS:
(16) TOTAL WALL UNITS

LENZA - 63 x 117 FIREPLACE - RIGHT ACCESS DOOR DESIGN - 12th COURSE

NOTE:
1. UNLESS OTHERWISE DIRECTED INSTALL AND SECURE COUNTERTOP WITH APPROVED ADHESIVE OR BONDING AGENT.

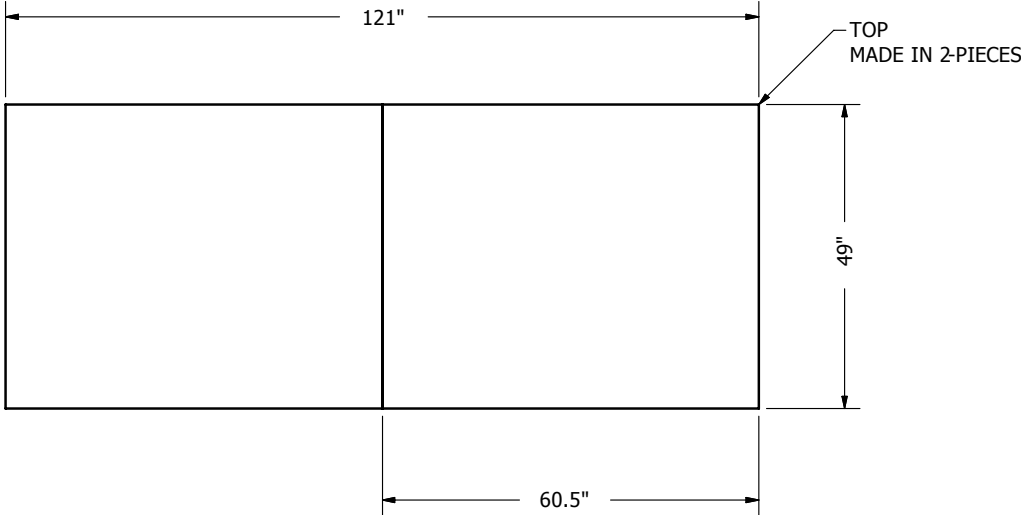

PLAN VIEW

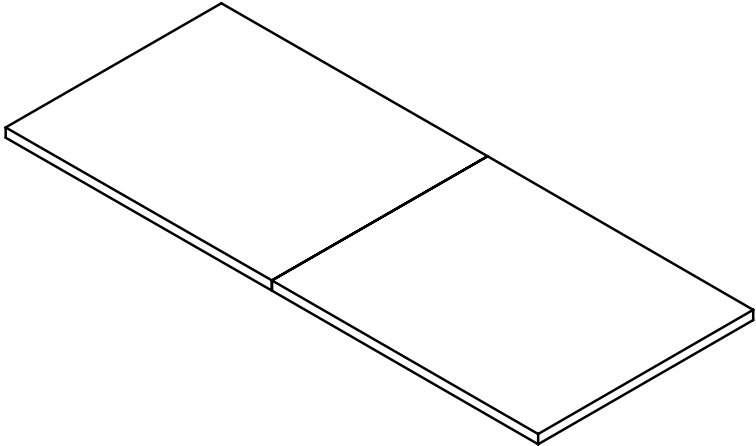

ISOMETRIC VIEW

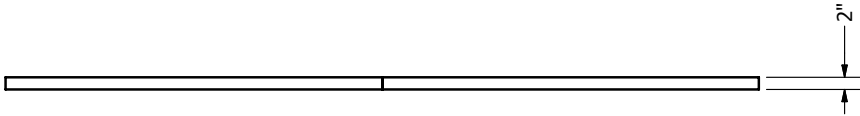

FRONT ELEVATION VIEW



SIDE ELEVATION VIEW

LENZA - 63 x 117 FIREPLACE - RIGHT ACCESS DOOR DESIGN - TOP COURSE