

OUTDOOR LIVING DESIGNS

LENZA

45 X 63 GRILL TOP - RIGHT DOOR DESIGN

LENZA - 45 x 63 GRILL TOP - RIGHT DOOR DESIGN

OUTDOOR LIVING DESIGNS

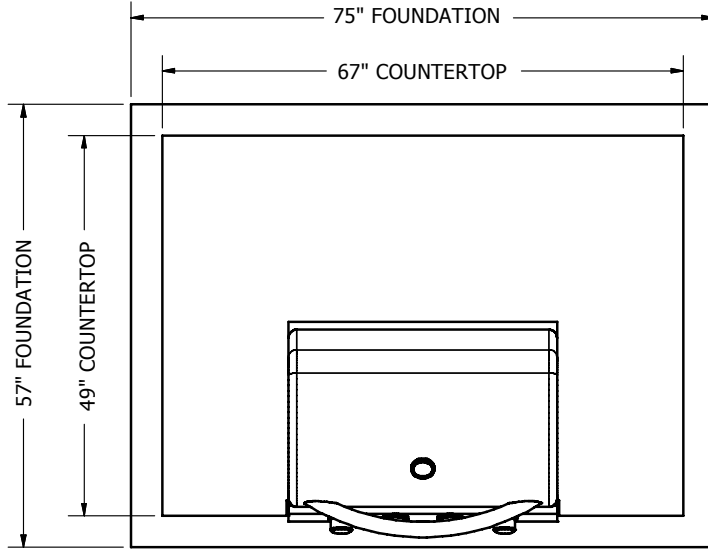

PLAN VIEW

NOTE:

1. WALL UNITS TO BE INSTALLED WITH CHANNEL ON THE BOTTOM SIDE IN ORDER TO GET THE PROPER CONTEMPORARY ESTHETIC LOOK. (WALL PRODUCT TO BE INVERTED 180 DEGREES FROM FINISHED PALLET WHEN INSTALLED).
2. SECURE EACH UNIT USING APPROVED ADHESIVE OR BONDING AGENT FOLLOWING APPLICATION DIRECTIONS PROVIDED BY PRODUCT SUPPLIER.
3. THIS DESIGN REQUIRES CUTTING UNITS TO PROPERLY FIT THE GRILL TOP AND ACCESS DOOR.
4. BUILT-IN GRILL INSERT AND ACCESS DOOR TO BE INSTALLED PER MANUFACTURES RECOMMENDATIONS.
5. STRUCTURAL SUPPORT FOR BLOCK UNITS OVER OPENINGS NOT SHOWN FOR VISUAL PURPOSES.
6. FOR PROPER INSTALLATION OF GAS GRILL REFER TO BLAZE OUTDOOR PRODUCTS - USE & CARE GUIDE GAS GRILLS BLZ-4LBM (NG/LP).
7. ALL DIMENSIONS ARE IN INCHES.

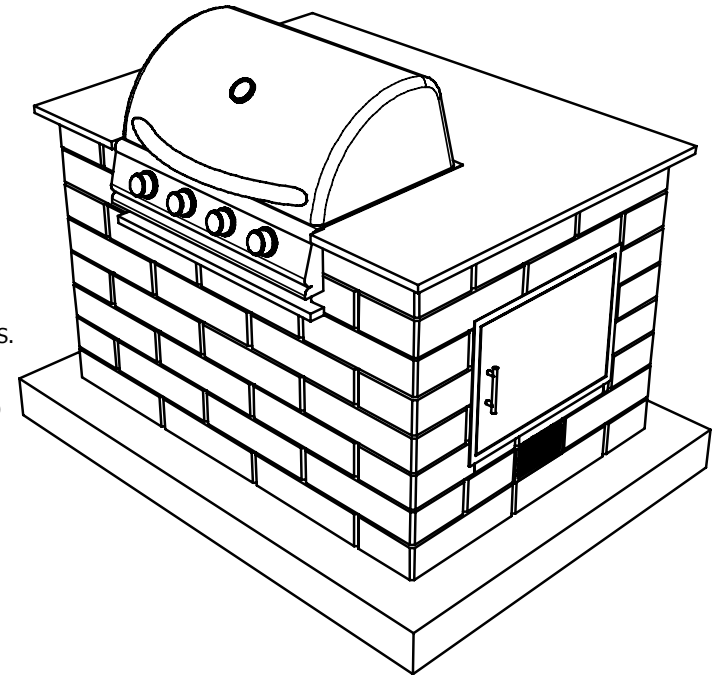

ISOMETRIC VIEW

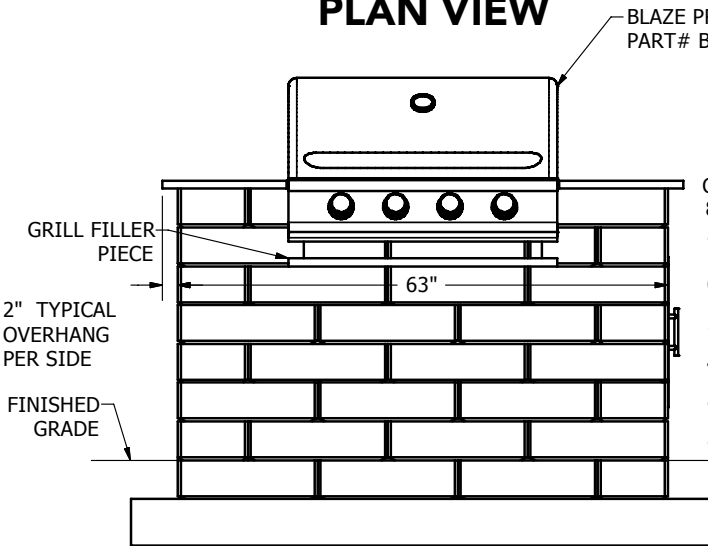

FRONT ELEVATION VIEW

BLAZE PRELUDE LBM 32-INCH 4-BURNER GRILL
PART# BLZ-4LBM-LP/NG

- COUNTERTOP COURSE
- 8th COURSE WALL
- 7th COURSE WALL
- 6th COURSE WALL
- 5th COURSE WALL
- 4th COURSE WALL
- 3rd COURSE WALL
- 2nd COURSE WALL
- 1st COURSE WALL

FOUNDATION LEVELING PAD

FINISHED GRADE

6" FOUNDATION

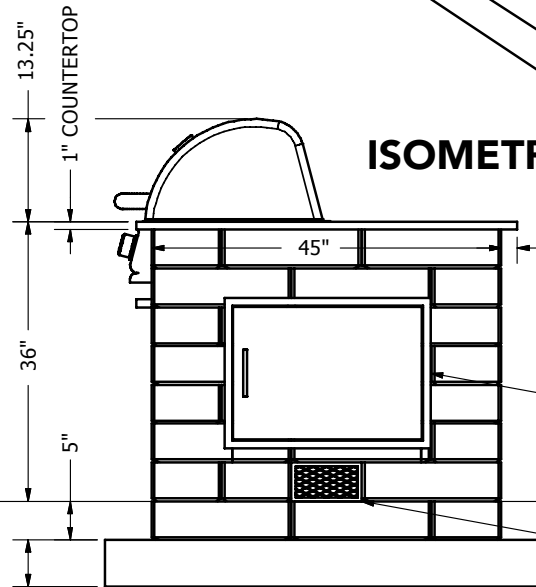

SIDE ELEVATION VIEW

13.25"

1" COUNTERTOP

36"

5"

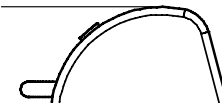

45" TYPICAL OVERHANG PER SIDE

TYPICAL OVERHANG PER SIDE

BLAZE 28-INCH SINGLE ACCESS DOOR HINGED (HORIZONTAL)
PART# BLZ-SH-2417-R-SC

VENT 5" X 9"

PRODUCT COUNTS:
(80) TOTAL WALL UNITS

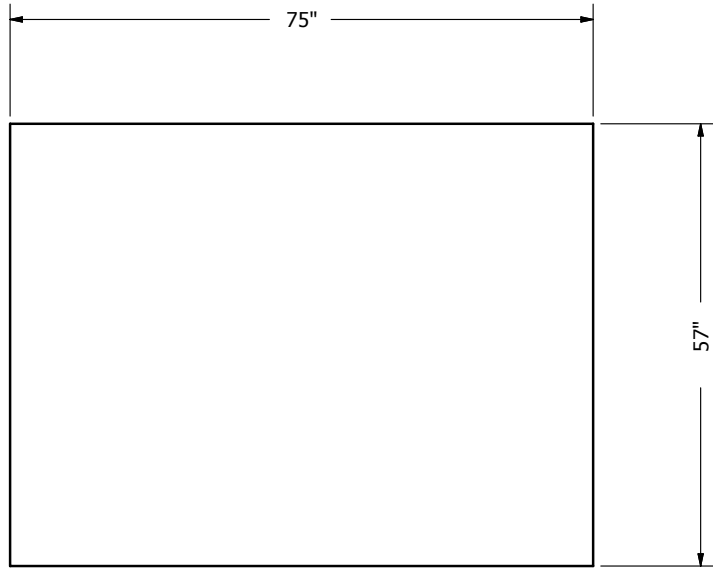

PLAN VIEW

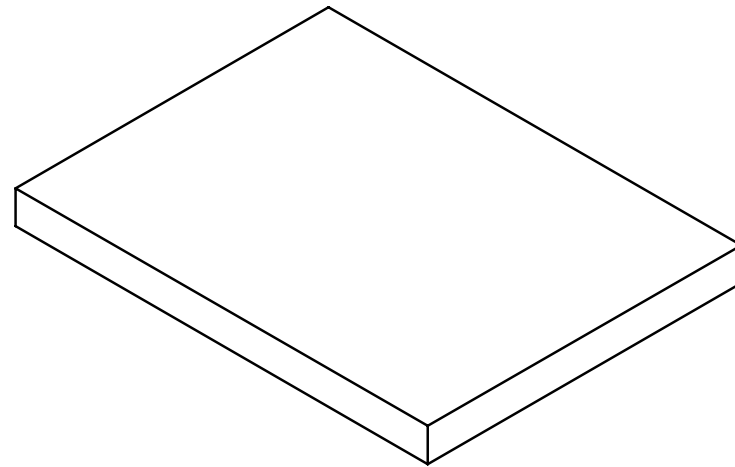

ISOMETRIC VIEW

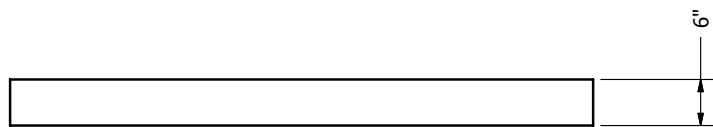

FRONT ELEVATION VIEW

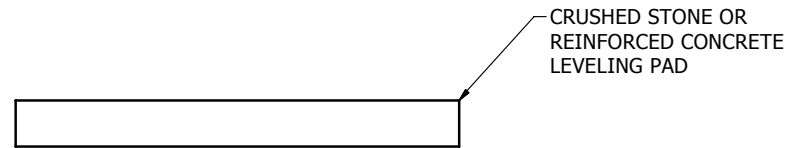

SIDE ELEVATION VIEW

LENZA - 45 x 63 GRILL TOP - RIGHT DOOR CUT DESIGN - FOUNDATION LEVELING PAD

NOTE:
1. WALL UNITS TO BE INSTALLED WITH CHANNEL ON THE BOTTOM SIDE
(PRODUCT IS TO BE INVERTED 180 DEGREES FROM FINISHED PALLET).

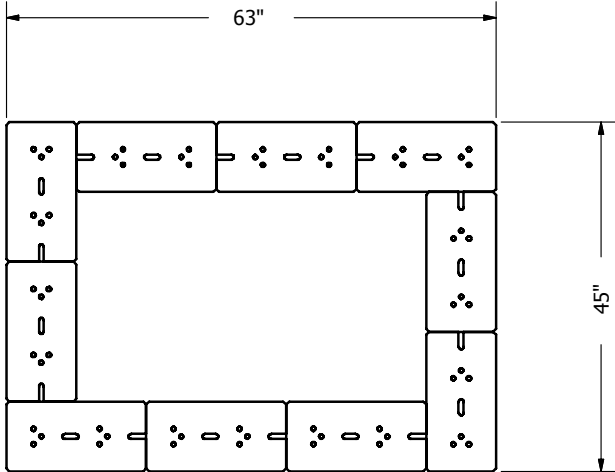

PLAN VIEW

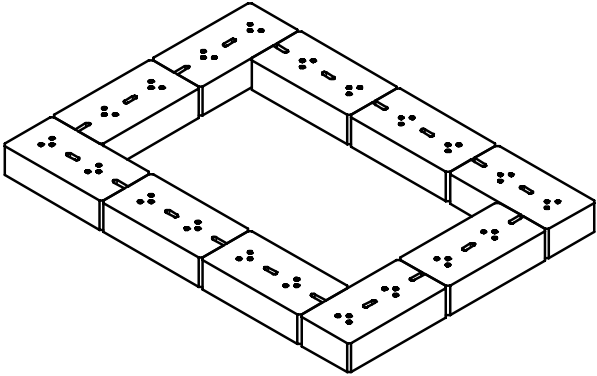

ISOMETRIC VIEW



ELEVATION VIEW



SIDE ELEVATION VIEW

PRODUCT COUNTS:
(10) TOTAL WALL UNITS

LENZA - 45 x 63 GRILL TOP - RIGHT DOOR CUT DESIGN - 1st COURSE

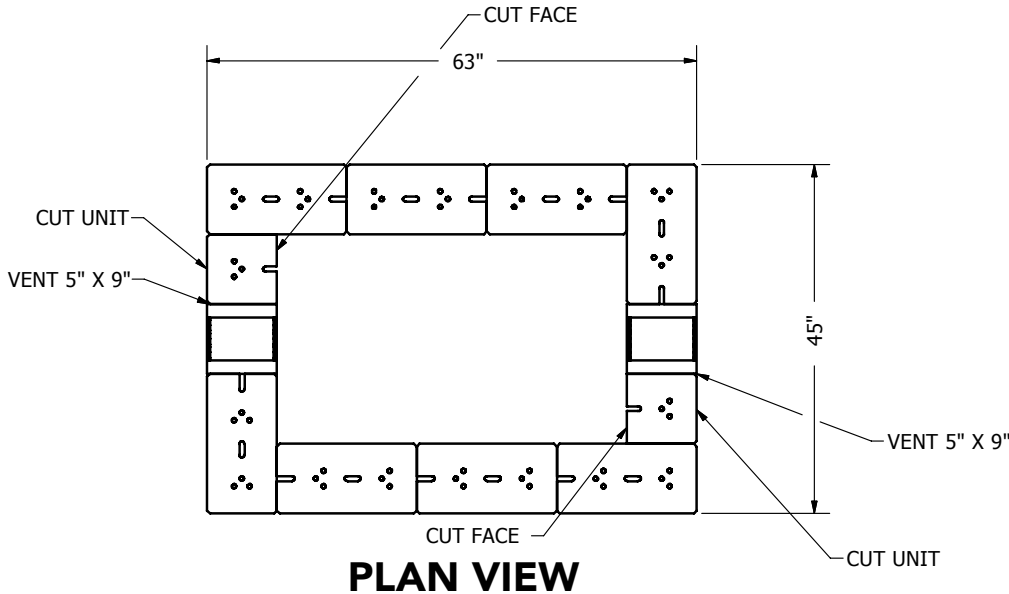

NOTE:
 1. WALL UNITS TO BE INSTALLED WITH CHANNEL ON THE BOTTOM SIDE (PRODUCT IS TO BE INVERTED 180 DEGREES FROM FINISHED PALLET).

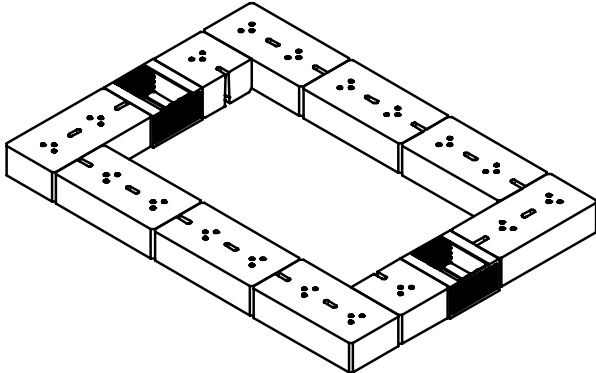

ISOMETRIC VIEW



FRONT ELEVATION VIEW

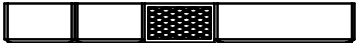

SIDE ELEVATION VIEW

LENZA - 45 x 63 GRILL TOP - RIGHT DOOR CUT DESIGN - 2nd COURSE

PRODUCT COUNTS:
 (10) TOTAL WALL UNITS

NOTE:
 1. WALL UNITS TO BE INSTALLED WITH CHANNEL ON THE BOTTOM SIDE
 (PRODUCT IS TO BE INVERTED 180 DEGREES FROM FINISHED PALLET).

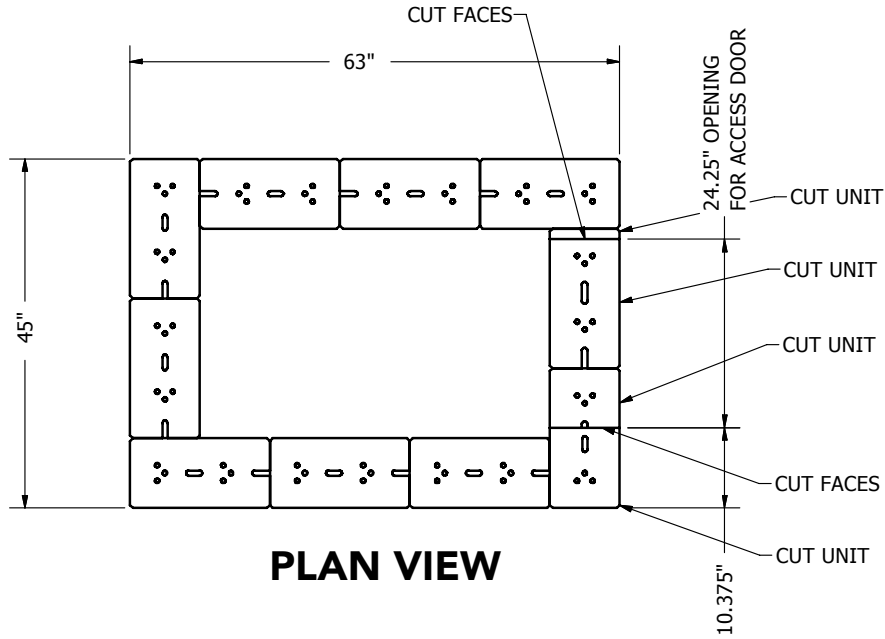

PLAN VIEW

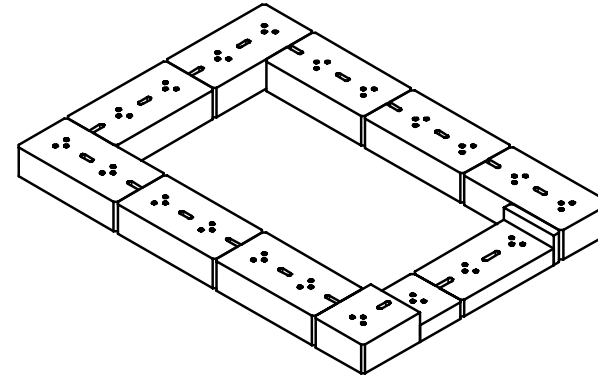

ISOMETRIC VIEW

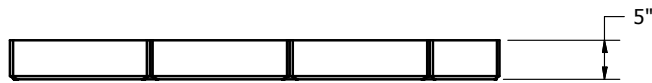

FRONT ELEVATION VIEW

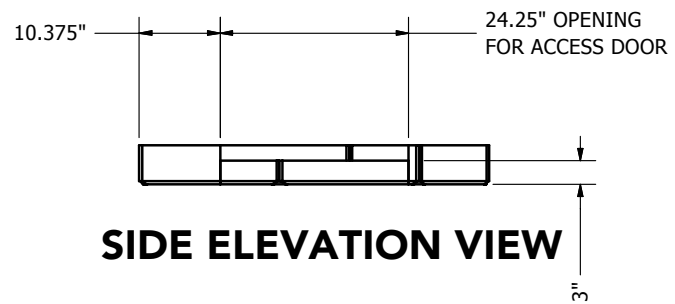

SIDE ELEVATION VIEW

PRODUCT COUNTS:
 (12) TOTAL WALL UNITS

LENZA - 45 x 63 GRILL TOP - RIGHT DOOR CUT DESIGN - 3rd COURSE

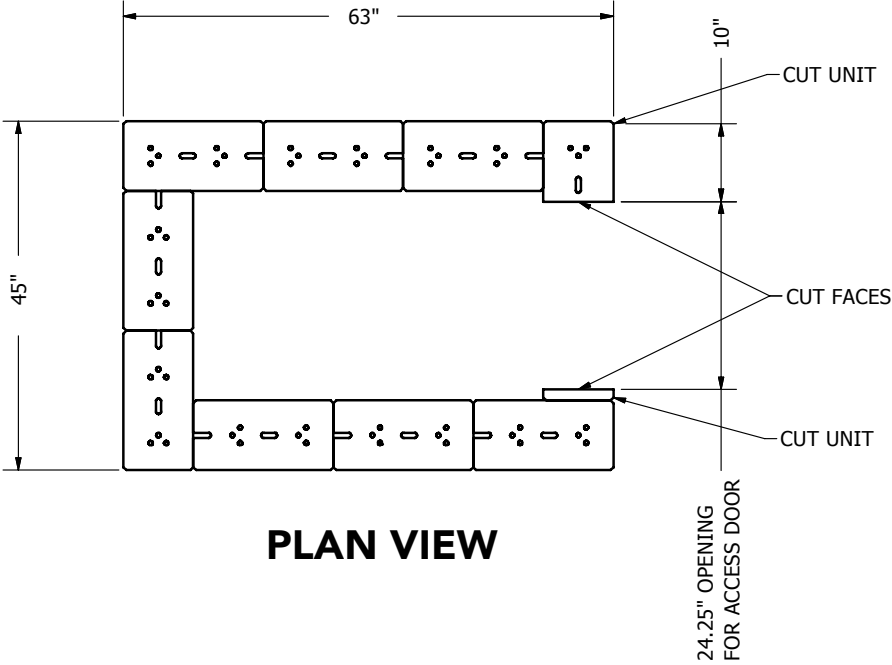

PLAN VIEW

NOTE:
 1. WALL UNITS TO BE INSTALLED WITH CHANNEL ON THE BOTTOM SIDE (PRODUCT IS TO BE INVERTED 180 DEGREES FROM FINISHED PALLET).

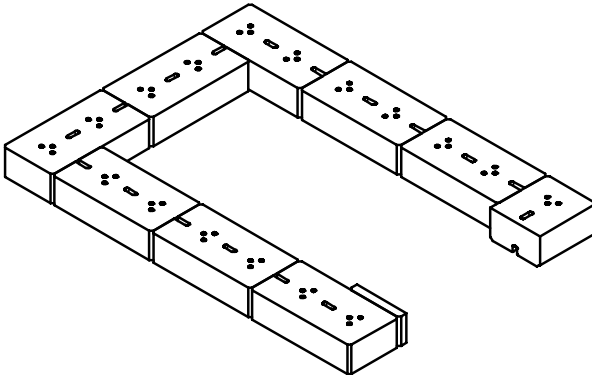

ISOMETRIC VIEW

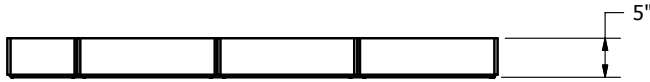

FRONT ELEVATION VIEW

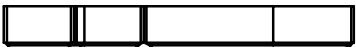

SIDE ELEVATION VIEW

PRODUCT COUNTS:
 (10) TOTAL CAP UNITS

LENZA - 45 x 63 GRILL TOP - RIGHT DOOR CUT DESIGN - 4th AND 6th COURSES

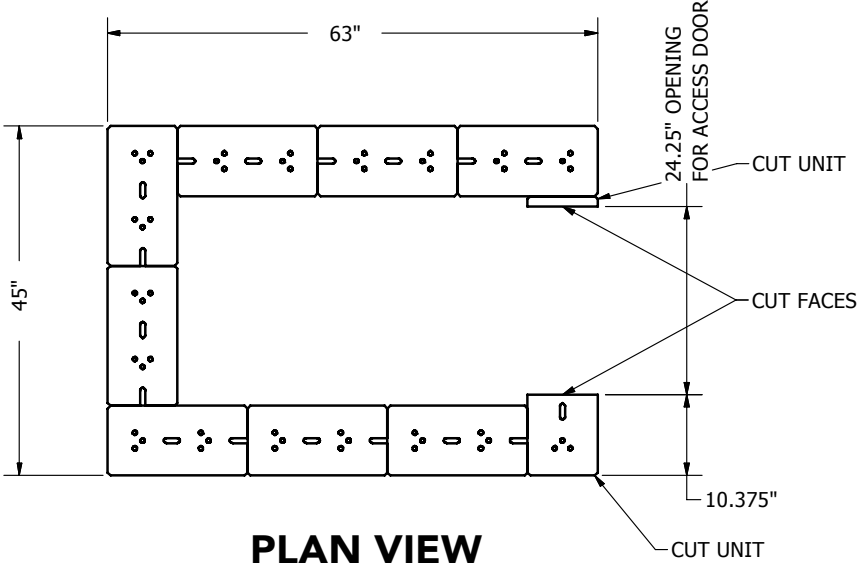

NOTE:
 1. WALL UNITS TO BE INSTALLED WITH CHANNEL ON THE BOTTOM SIDE (PRODUCT IS TO BE INVERTED 180 DEGREES FROM FINISHED PALLET).

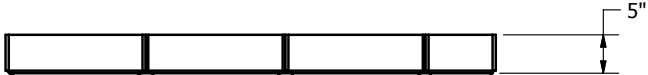
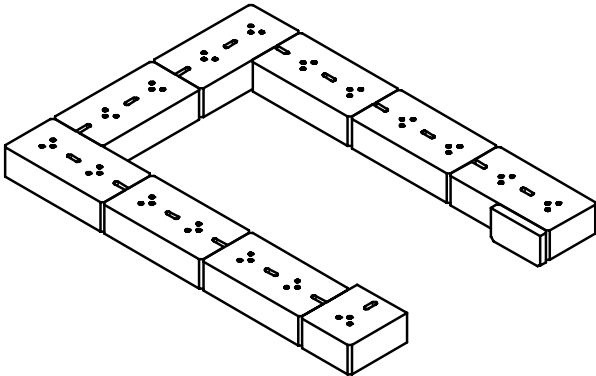

PRODUCT COUNTS:
 (10) TOTAL CAP UNITS

LENZA - 45 x 63 GRILL TOP - RIGHT DOOR CUT DESIGN - 7th COURSE

- NOTE:**
1. WALL UNITS TO BE INSTALLED WITH CHANNEL ON THE BOTTOM SIDE (PRODUCT IS TO BE INVERTED 180 DEGREES FROM FINISHED PALLET).
 2. GRILL FILLER PIECE IS TO BE MADE FROM THE SAME MATERIAL AS THE COUNTER TOP, (1" ± THICK).
 3. UNLESS OTHERWISE DIRECTED INSTALL AND SECURE GRILL FILLER PIECE WITH APPROVED ADHESIVE OR BONDING AGENT.

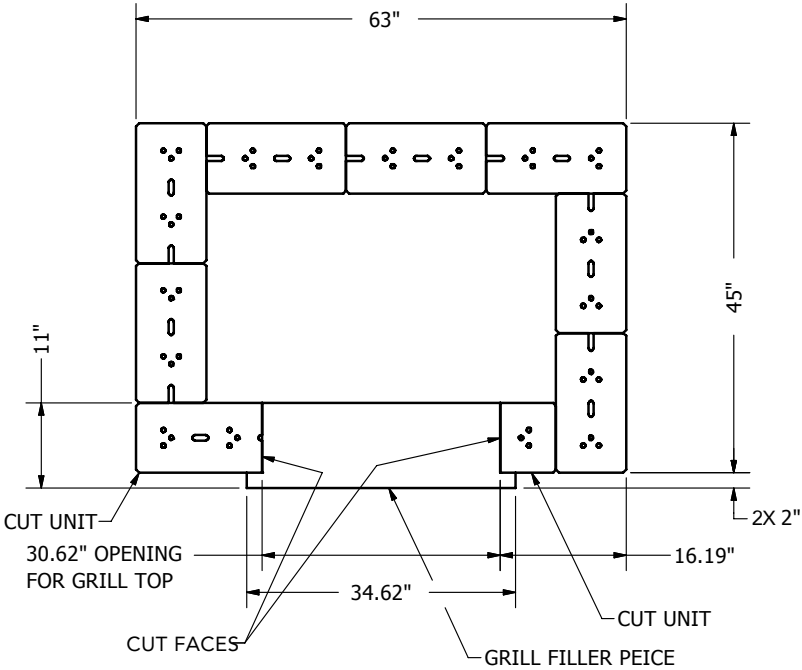

PLAN VIEW

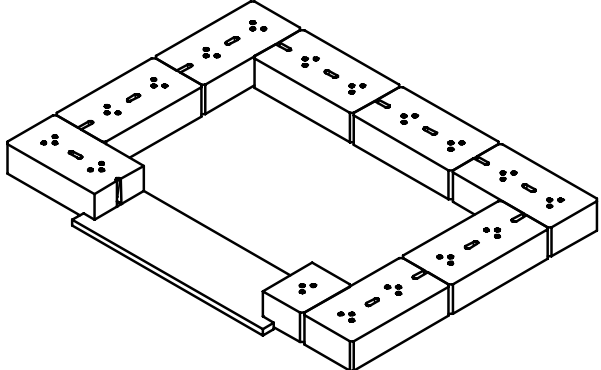

ISOMETRIC VIEW

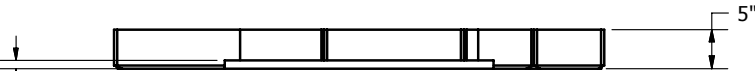

FRONT ELEVATION VIEW



SIDE ELEVATION VIEW

LENZA - 45 x 63 GRILL TOP - RIGHT DOOR CUT DESIGN - 8th COURSE

PRODUCT COUNTS:
(9) TOTAL WALL UNITS

NOTE:
1. WALL UNITS TO BE INSTALLED WITH CHANNEL ON THE BOTTOM SIDE
(PRODUCT IS TO BE INVERTED 180 DEGREES FROM FINISHED PALLET).

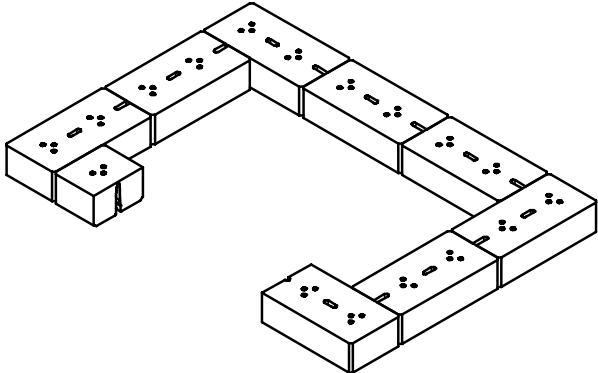
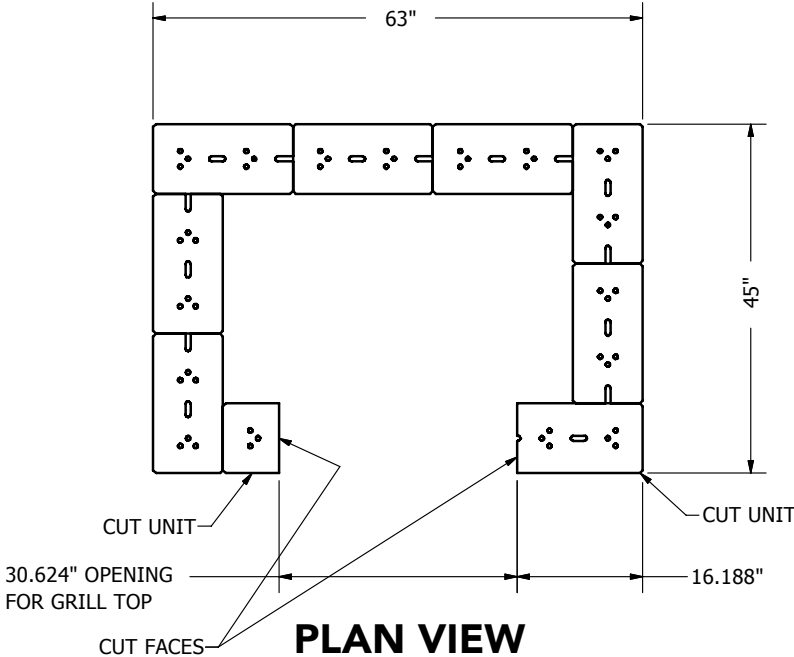

ISOMETRIC VIEW



FRONT ELEVATION VIEW



SIDE ELEVATION VIEW

PRODUCT COUNTS:
(9) TOTAL WALL UNITS

LENZA - 45 x 63 GRILL TOP - RIGHT DOOR CUT DESIGN - 9th COURSE

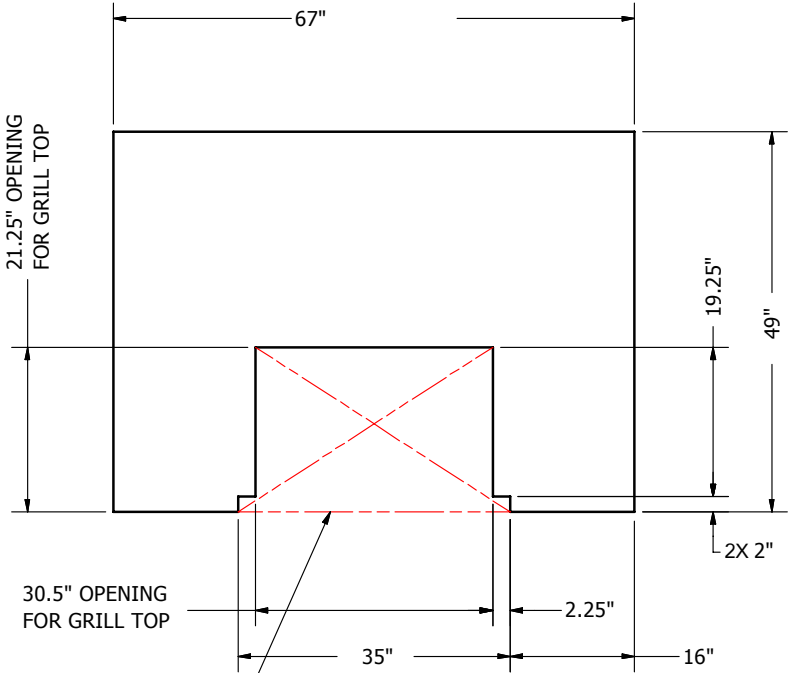

PLAN VIEW

BUILT-IN GRILL COUNTERTOP CUT OUT AS PER MANUFACTURES RECOMENDATIONS

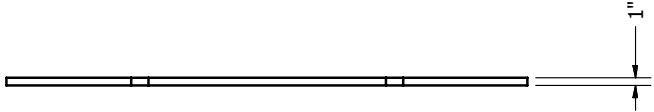

FRONT ELEVATION VIEW

NOTE:
1. UNLESS OTHERWISE DIRECTED INSTALL AND SECURE COUNTERTOP WITH APPROVED ADHESIVE OR BONDING AGENT.

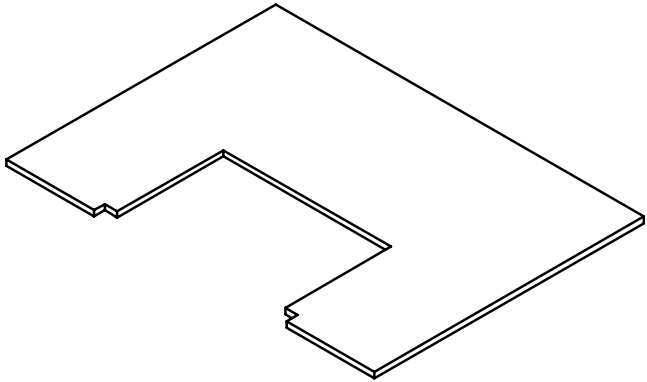

ISOMETRIC VIEW



SIDE ELEVATION VIEW

LENZA - 45 x 63 GRILL TOP - RIGHT DOOR CUT DESIGN - COUNTERTOP COURSE